

# Digital Video Camera Recorder <sup>Mini DV</sup> Digital Video Cassette

## Operating Instructions

Before operating the unit, please read this manual thoroughly, and retain it for future reference.

## Owner's Record

The model and serial numbers are located on the bottom. Record the serial number in the space provided below. Refer to these numbers whenever you call upon your Sony dealer regarding this product.

Model No. **DCR-TRV** \_\_\_\_\_ Model No. **AC**- \_\_\_\_\_

Serial No. \_\_\_\_\_ Serial No. \_\_\_\_\_

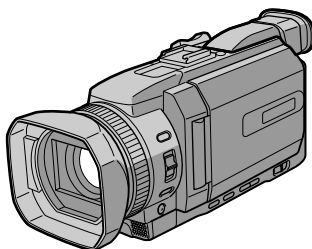

DCR-TRV950

Digital Handycam  
Network Handycam



## DCR-TRV940/TRV950

## Welcome!

Congratulations on your purchase of this Sony Handycam. With your Handycam, you can capture life's precious moments with superior picture and sound quality. Your Handycam is loaded with advanced features, but at the same time it is very easy to use. You will soon be producing home video that you can enjoy for years to come.

## WARNING

To prevent fire or shock hazard, do not expose the unit to rain or moisture.

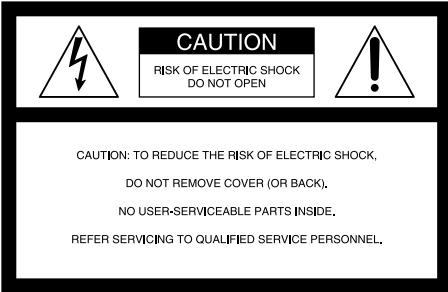

This symbol is intended to alert the user to the presence of uninsulated "dangerous voltage" within the product's enclosure that may be of sufficient magnitude to constitute a risk of electric shock to persons.



This symbol is intended to alert the user to the presence of important operating and maintenance (servicing) instructions in the literature accompanying the appliance.

## CAUTION

The use of optical instruments with this product will increase eye hazard. As the laser beam used in this Handycam is harmful to eyes, do not attempt to disassemble the cabinet.

Refer to servicing to qualified personnel only.

## NOTICE

If static electricity or electromagnetism causes data transfer to discontinue midway (fail), restart the application or disconnect and connect the USB cable again.

## For customers in the U.S.A. and CANADA

### CAUTION

TO PREVENT ELECTRIC SHOCK, MATCH WIDE BLADE OF PLUG TO WIDE SLOT, FULLY INSERT.

### RECYCLING LITHIUM-ION BATTERIES

Lithium-Ion batteries are recyclable.

You can help preserve our environment by returning your used rechargeable batteries to the collection and recycling location nearest you.



For more information regarding recycling of rechargeable batteries, call toll free 1-800-822-8837, or visit <http://www.rbrcc.org/>.

Caution: Do not handle damaged or leaking Lithium-Ion batteries.

### DCR-TRV950 only

Countries and areas where you can use network functions are restricted.

For details, refer to the separate Network Operating Instructions.

## For customers in the U.S.A.

If you have any questions about this product, you may call:

Sony Customer Information Center 1-800-222-SONY (7669)

The number below is for the FCC related matters only.

### Regulatory Information

#### Declaration of Conformity

Trade Name: SONY  
Model No.: DCR-TRV950  
Responsible Party: Sony Electronics Inc.  
Address: 680 Kinderkamack Road, Oradell, NJ07649 U.S.A.

Telephone No.: 201-930-6972  
This device complies with Part 15 of the FCC Rules. Operation is subject to the following two conditions: (1) This device may not cause harmful interference, and (2) this device must accept any interference received, including interference that may cause undesired operation.

## “Memory Stick”

This device complies with Part 15 of the FCC Rules. Operation is subject to the following two conditions: (1) This device may not cause harmful interference, and (2) this device must accept any interference received, including interference that may cause undesired operation.

### CAUTION

You are cautioned that any changes or modifications not expressly approved in this manual could void your authority to operate this equipment.

## DCR-TRV950 only

### IMPORTANT NOTE

To comply with FCC RF exposure compliance requirements, the following antenna installation and device operating configurations must be satisfied: the antenna has been installed by the manufacturer and no changes can be made.

### Note:

This equipment has been tested and found to comply with the limits for a Class B digital device, pursuant to Part 15 of the FCC Rules. These limits are designed to provide reasonable protection against harmful interference in a residential installation. This equipment generates, uses, and can radiate radio frequency energy and, if not installed and used in accordance with the instructions, may cause harmful interference to radio communications. However, there is no guarantee that interference will not occur in a particular installation. If this equipment does cause harmful interference to radio or television reception, which can be determined by turning the equipment off and on, the user is encouraged to try to correct the interference by one or more of the following measures:

- Reorient or relocate the receiving antenna.
- Increase the separation between the equipment and receiver.
- Connect the equipment into an outlet on a circuit different from that to which the receiver is connected.
- Consult the dealer or an experienced radio/TV technician for help.

The supplied interface cable must be used with the equipment in order to comply with the limits for a digital device pursuant to Subpart B of Part 15 of FCC Rules.

## For customers in CANADA

## “Memory Stick”

This Class B digital apparatus complies with Canadian ICES-003.

## DCR-TRV950 only

The term “IC:” before the radio certification number only signifies that Industry Canada technical specifications were met.

# Main Features

---

## Recording moving pictures or still images, and playing them back

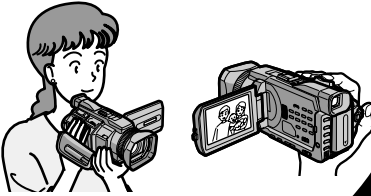

- Recording moving pictures on a tape (p. 26)
- Recording still images on a tape (p. 51)
- Playing back a tape (p. 39)
- Recording still images on a “Memory Stick” (p. 46, 135)
- Recording moving pictures on a “Memory Stick” (p. 153)
- Viewing still images recorded on a “Memory Stick” (p. 165)
- Viewing moving pictures on a “Memory Stick” (p. 168)

Main Features

- Viewing images recorded on a “Memory Stick” using the USB cable (p. 199, 203)
- Viewing moving pictures recorded on tapes using the USB cable (p. 194)
- Capturing images on your computer from your camcorder using the USB cable (p. 196)
- Converting an analog signal to digital to capture images onto your computer (p. 204)

## Capturing images on your computer

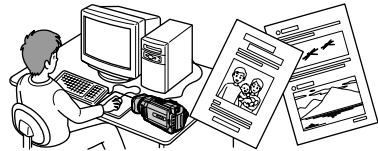

### Accessing the Internet via a Bluetooth compliant device (DCR-TRV950 only)

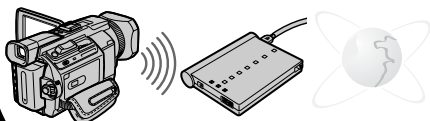

Accessing the Internet, sending/receiving your e-mail. For details, refer to the Network Function Operating Instructions supplied with your camcorder. (DCR-TRV950 only) (p. 205)

### Other uses

#### Functions for adjusting the exposure in the recording mode

- BACK LIGHT (p. 34)
- SPOT LIGHT (p. 35)
- Recording images with the flash (p. 48, 139)
- PROGRAM AE (p. 67)
- Adjusting the exposure manually (p. 74)
- Flexible Spot Meter (p. 75)

#### Functions for giving images more impact

- Digital zoom (p. 31)  
The default setting is **OFF**. (To zoom greater than 12x, select the digital zoom power in **D ZOOM** in the menu settings.)
- Fader (p. 55)
- Picture effect (p. 58)
- Digital effect (p. 59)
- Titles (p. 119)
- MEMORY MIX (p. 148)

#### Functions for giving a natural appearance to your recordings

- Sports lesson (p. 67)
- Landscape (p. 67)
- Manual focus (p. 76)
- Spot Focus (p. 78)

#### Functions for use with recorded tapes

- END SEARCH/EDITSEARCH/Rec Review (p. 37)
- DATA CODE (p. 41)
- Tape PB ZOOM (p. 86)
- ZERO SET MEMORY (p. 88)
- TITLE SEARCH (p. 89)
- Digital program editing (p. 98, 160)

# Table of contents

---

<b>Main Features</b> .....	4
----------------------------	---

---

## Quick Start Guide

– Recording on a tape .....	8
– Recording on a “Memory Stick” .....	10

---

## Getting Started

Using this manual .....	12
Checking supplied accessories .....	14
Step 1 Preparing the power supply ...	15
Installing the battery pack .....	15
Charging the battery pack .....	16
Connecting to a wall outlet .....	19
Step 2 Setting the date and time .....	20
Step 3 Inserting a cassette .....	23
Step 4 Using the touch panel .....	24

---

## Recording – Basics

Recording a picture .....	26
Shooting backlit subjects	
– BACK LIGHT .....	34
Shooting subjects lit by strong light	
– SPOT LIGHT .....	35
Self-timer recording .....	36
Checking recordings	
– END SEARCH /	
EDITSEARCH / Rec Review .....	37

---

## Playback – Basics

Playing back a tape .....	39
To display the screen indicators	
– Display function .....	41
Viewing the recording on TV .....	45

---

## Advanced Recording Operations

Recording still images on a “Memory Stick” during tape recording .....	46
Recording still images on a tape	
– Tape Photo recording .....	51
Using the wide mode .....	53
Using the fader .....	55
Using special effects	
– Picture effect .....	58
Using special effects	
– Digital effect .....	59
Presetting the adjustment for picture quality	
– Custom preset .....	62
Using the guide frame .....	64

Shooting with the zebra pattern .....	65
Using the color bar .....	66
Shooting with manual adjustment .....	67
Using the PROGRAM AE .....	67
Adjusting the shutter speed .....	70
Adjusting the white balance .....	72
Adjusting the exposure .....	74
Using the spot light-metering	
– Flexible Spot Meter .....	75
Focusing manually .....	76
Using the spot focus – Spot Focus .....	78
Adjusting recording level manually	
– Sound recording level .....	79
Interval recording .....	81
Frame by frame recording	
– Frame recording .....	83

---

## Advanced Playback Operations

Playing back tapes with picture effect .....	84
Playing back tapes with digital effect .....	85
Enlarging images recorded on tapes	
– Tape PB ZOOM .....	86
Quickly locating a scene	
– ZERO SET MEMORY .....	88
Searching the boundaries of a recorded tape by title – TITLE SEARCH .....	89
Searching a recording by date	
– DATE SEARCH .....	90
Searching for a photo – PHOTO SEARCH/PHOTO SCAN .....	92

---

## Editing

Dubbing a tape .....	95
Dubbing only desired scenes	
– Digital program editing (on tapes) .....	98
Recording video or TV programs .....	109
Inserting a scene from a VCR	
– Insert Editing .....	113
Audio dubbing .....	115
Superimposing a title .....	119
Making your own titles .....	122
Labeling a cassette .....	124

## Table of contents

---

### **“Memory Stick” Operations**

Using a “Memory Stick”	
– Introduction .....	126
Recording still images on a “Memory Stick”	
– Memory Photo recording .....	135
Recording images from a tape as still images .....	144
Superimposing a still image in the “Memory Stick” on an image	
– MEMORY MIX .....	148
Recording moving pictures on a “Memory Stick”	
– MPEG movie recording .....	153
Recording pictures from a tape as a moving picture .....	156
Recording edited pictures from a tape as a moving picture	
– Digital program editing (on a “Memory Stick”) .....	160
Copying still images from a tape	
– PHOTO SAVE .....	163
Viewing still images	
– Memory photo playback .....	165
Viewing moving pictures	
– MPEG movie playback .....	168
Copying images recorded on a “Memory Stick” to a tape .....	171
Enlarging still images recorded on a “Memory Stick”	
– Memory PB ZOOM .....	173
Playing back images in a continuous loop – SLIDE SHOW .....	175
Preventing accidental erasure	
– Image protection .....	176
Deleting images – DELETE .....	177
Writing a print mark	
– PRINT MARK .....	180
Using the optional printer .....	181

### **Viewing Images Using your Computer**

Viewing images on your computer	
– Introduction .....	183
Connecting your camcorder to your computer using the USB cable	
– For Windows users .....	186
Viewing images recorded on a tape on your computer	
– For Windows users .....	194

Viewing images recorded on a “Memory Stick” on your computer	
– For Windows users .....	199
Connecting your camcorder to your computer using the USB cable	
– For Macintosh users .....	201
Viewing images recorded on a “Memory Stick” on your computer	
– For Macintosh users .....	203
Capturing images from an analog video unit on your computer	
– Signal convert function .....	204

---

### **Using the Network function (DCR-TRV950 only)**

Accessing the network .....	205
For the details, refer to the Network Function Operating Instructions supplied with your camcorder.	

---

### **Customizing Your Camcorder**

Changing the default settings with the menu .....	207
---	-----

---

### **Troubleshooting**

Types of trouble and how to correct trouble .....	218
Self-diagnosis display .....	225
Warning indicators and messages ....	226

---

### **Additional Information**

Usable cassettes .....	228
About the “InfoLITHIUM” battery pack .....	231
About i.LINK .....	233
Using your camcorder abroad .....	235
Maintenance information and precautions .....	236
Specifications .....	242

---

### **Quick Reference**

Identifying parts and controls .....	244
Index .....	254

# Quick Start Guide – Recording on a tape

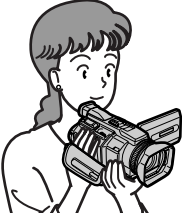

This chapter introduces you to the basic features to recorded pictures on tapes of your camcorder. See the page in parentheses “( )” for more information.

## 1 Connecting the power cord (p. 19)

Use the battery pack when using your camcorder outdoors (p. 15).

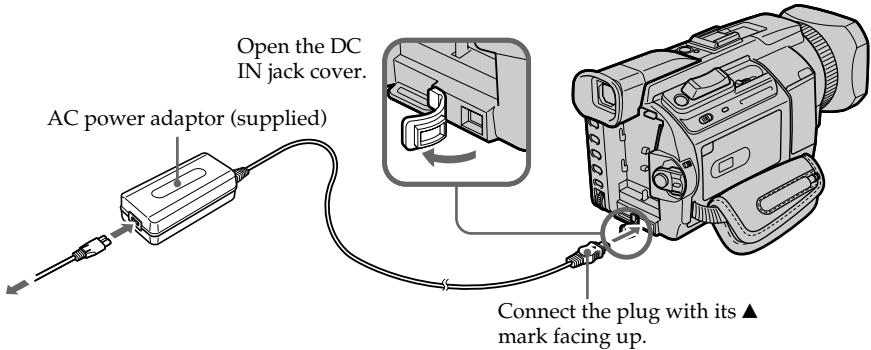

## 2 Inserting a cassette (p. 23)

- 1 Slide OPEN/▲ EJECT in the direction of the arrow to open the lid.

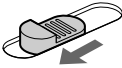

- 2 Insert the cassette straight as far as possible into the cassette compartment with the window facing out and the write-protect tab facing upward.

- 3 Close the cassette compartment by pressing on the cassette compartment. After the cassette compartment goes down completely, close the lid until it clicks.

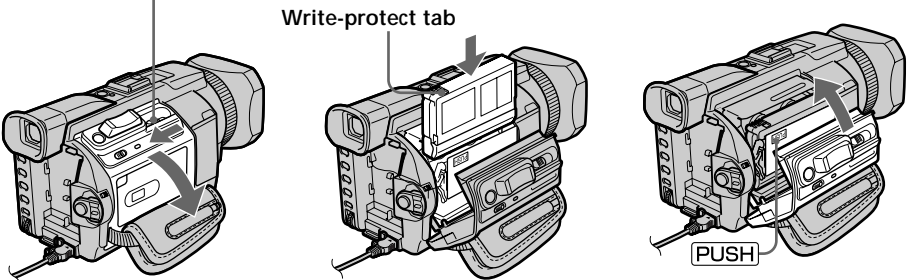



### 3 Recording a picture (p. 26)

- 1 Remove the lens cap.

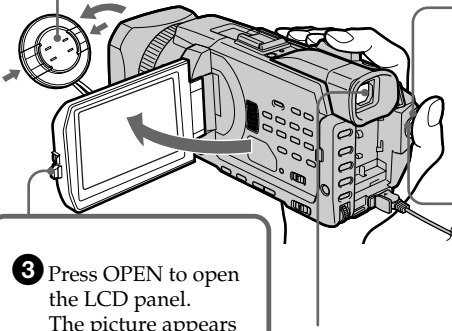

- 2 Set the POWER switch to CAMERA while pressing the small green button.

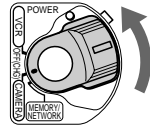

- 3 Press OPEN to open the LCD panel. The picture appears on the screen.

- 4 Press START/STOP. Your camcorder starts recording. To stop recording, press START/STOP again.



#### Viewfinder

When the LCD panel is closed, use the viewfinder with your eye against the eyecup.

Adjust the viewfinder lens to your eyesight (p. 30).

When you purchase your camcorder, the clock setting is set to off. If you want to record the date and time for a picture, set the clock setting before recording (p. 20).

### 4 Monitoring the playback picture on the LCD screen (p. 39)

- 1 Set the POWER switch to VCR while pressing the small green button.

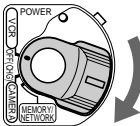

- 2 Press ◀◀ to rewind the tape.

REW ◀◀



- 3 Press ▶▶ to start playback.

PLAY ▶▶

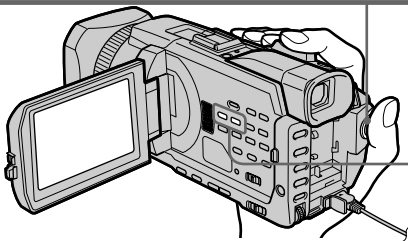

#### NOTE

Do not pick up your camcorder by holding the viewfinder, the flash, the LCD panel or the battery pack.

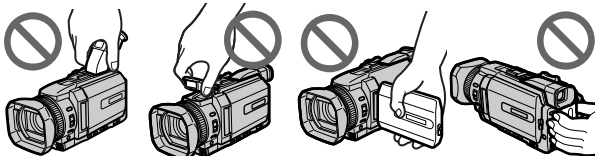

# Quick Start Guide - Recording on a "Memory Stick"

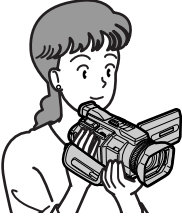

This chapter introduces you to the basic features to record on a "Memory Stick" of your camcorder. See the page in parentheses "( )" for more information.

## 1 Connecting the power cord (p. 19)

Use the battery pack when using your camcorder outdoors (p. 15).

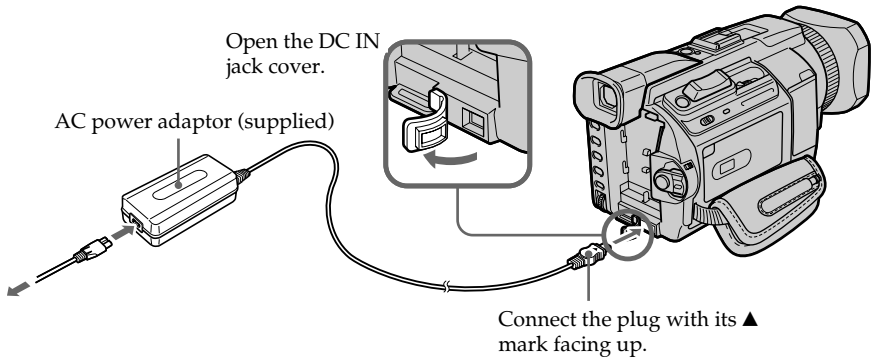

## 2 Inserting a "Memory Stick" (p. 128)

- 1 Slide MEMORY OPEN in the direction of the arrow to open the "Memory Stick" slot.

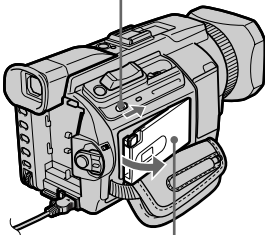

"Memory Stick" slot

- 2 Insert a "Memory Stick" in the "Memory Stick" slot as far as it can go with the ► mark facing up as illustrated.

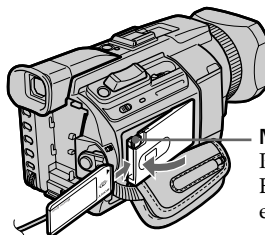

**MEMORY EJECT**  
Press the MEMORY EJECT once lightly to eject it.

### 3

## Recording a still image on a "Memory Stick" (p. 135)

- 3** Press OPEN to open the LCD panel. The picture appears on the screen.

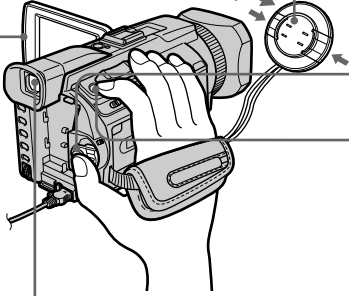

- 1** Remove the lens cap.

- 2** Set the POWER switch to MEMORY/NETWORK (DCR-TRV950 only) while pressing the small green button.

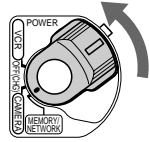

- 4** Press PHOTO lightly. You can start recording when the small green button on the screen stops flashing, and lights up.

- 5** Press PHOTO deeper. The image while pressing the button deeply is recorded on the "Memory Stick."

#### Viewfinder

When the LCD panel is closed, use the viewfinder with your eye against the eyecup.

Adjust the viewfinder lens to your eyesight (p. 30).

When you purchase your camcorder, the clock setting is set to off. If you want to record the date and time for a picture, set the clock setting before recording (p. 20).

### 4

## Monitoring the playback still images on the LCD screen (p. 165)

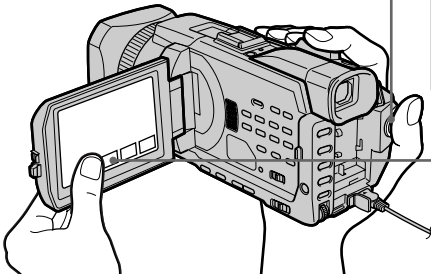

- 1** Set the POWER switch to MEMORY/NETWORK (DCR-TRV950 only) or VCR while pressing the small green button.

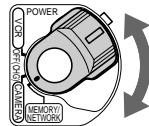

- 2** Press PLAY or  PB. The last recorded image is displayed.

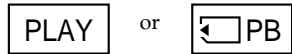

#### NOTE

Do not pick up your camcorder by holding the viewfinder, the flash, the LCD panel or the battery pack.

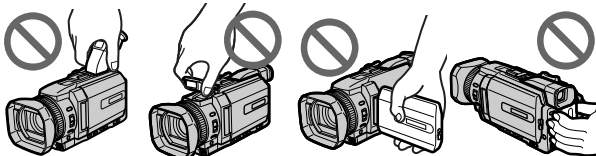

# Using this manual

The instructions in this manual are for the two models listed in the table below. Before you start reading this manual and operating your camcorder, check the model number by looking at the bottom of your camcorder. The DCR-TRV950 is the model used for illustration purposes. Otherwise, the model name is indicated in the illustrations. Any differences in operation are clearly indicated in the text, for example, “DCR-TRV950 only”.

As you read through this manual, buttons and settings on your camcorder are shown in capital letters.

e.g. Set the POWER switch to CAMERA.

When you carry out an operation, you can hear a beep to indicate that the operation is being carried out.

## Types of differences

DCR-	TRV940	TRV950
Mark on the POWER switch	MEMORY	MEMORY/NETWORK
Network function	—	●

- Provided
- Not provided

## Note on Cassette Memory

Your camcorder is based on the DV format. You can use only mini DV cassettes with your camcorder. We recommend that you use a tape with cassette memory **CM**.

Functions that require different operations depending on whether or not the tape has a cassette memory are:

- END SEARCH (p. 37)
- DATE SEARCH (p. 90)
- PHOTO SEARCH (p. 92)

Functions you can operate only with the cassette memory are:

- TITLE SEARCH (p. 89)
- Superimposing a title (p. 119)
- Labeling a cassette (p. 124)

For details of cassette types, see page 228.

 You see this mark in the introduction of features that are operated only with cassette memory.

Cassettes with cassette memory are marked by **CM** (Cassette Memory).

### Note on TV color systems

TV color systems differ depending on the country or region. To view your recordings on a TV, you need an NTSC system-based TV.

### Copyright precautions

Television programs, films, video tapes, and other materials may be copyrighted. Unauthorized recording of such materials may be contrary to the copyright laws.

### Precautions on camcorder care

#### Lens and LCD screen/finder (on mounted models only)

- The LCD screen and the finder are manufactured using extremely high-precision technology, so over 99.99% of the pixels are operational for effective use. However, there may be some tiny black points and/or bright points (white, red, blue or green in color) that constantly appear on the LCD screen and the finder. These points are normal in the manufacturing process and do not affect the recording in any way.
- Do not let your camcorder get wet. Keep your camcorder away from rain and sea water. Letting your camcorder get wet may cause your camcorder to malfunction. Sometimes this malfunction cannot be repaired [a].
- Never leave your camcorder exposed to temperatures above 60°C (140°F), such as in a car parked in the sun or under direct sunlight [b].
- Be careful when placing the camera near a window or outdoors. Exposing the LCD screen, the finder or the lens to direct sunlight for long periods may cause malfunctions [c].
- Do not directly shoot the sun. Doing so might cause your camcorder to malfunction. Take pictures of the sun in low light conditions such as dusk [d].

[a]

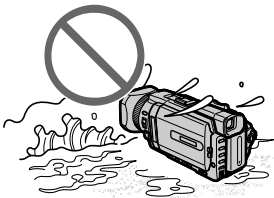

[b]

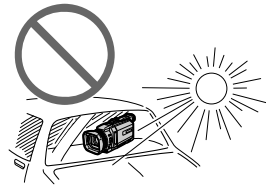

[c]

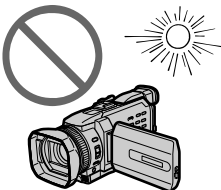

[d]

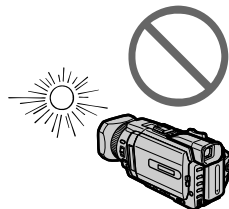

# Checking supplied accessories

Make sure that the following accessories are supplied with your camcorder.

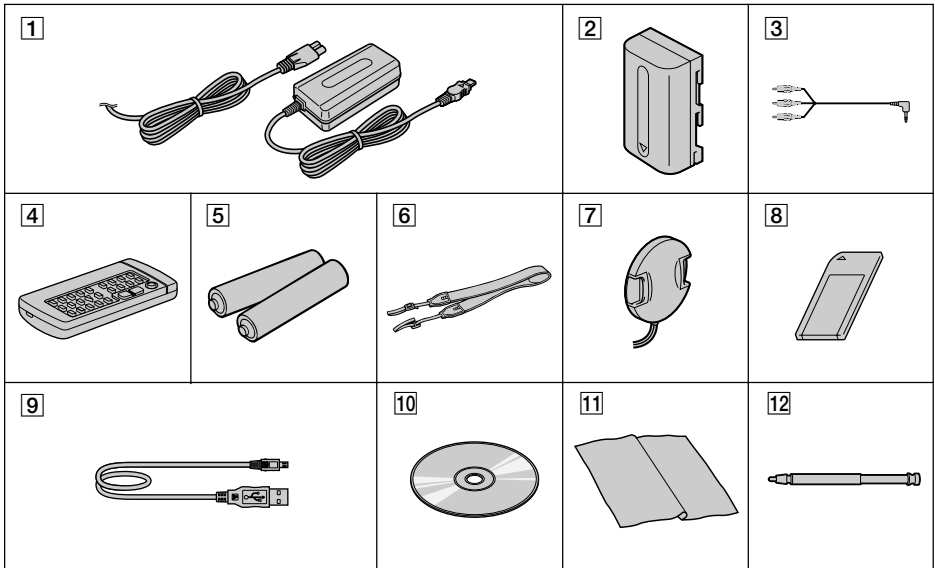

- 1 AC-L10A/L10B/L10C AC power adaptor (1), power cord (1) (p. 16)
- 2 NP-FM50 battery pack (1) (p. 15, 16)
- 3 A/V connecting cable (1) (p. 45)
- 4 Wireless Remote Commander (1) (p. 250)
- 5 Size AA (R6) battery for Remote Commander (2) (p. 251)
- 6 Shoulder strap (1)

- 7 Lens cap (1) (p. 26)
- 8 "Memory Stick" (1) (p. 126)
- 9 USB cable (1) (p. 183)
- 10 CD-ROM (SPVD-008 USB Driver) (1) (p. 188)
- 11 Cleaning cloth (1) (p. 237)
- 12 Stylus (1) (DCR-TRV950 only) (p. 206)

Contents of the recording cannot be compensated if recording or playback is not made due to a malfunction of the camcorder, storage media, etc.

# Step 1 Preparing the power supply

## Installing the battery pack

- (1) Lift up the viewfinder.
- (2) Slide the battery pack down until it clicks.

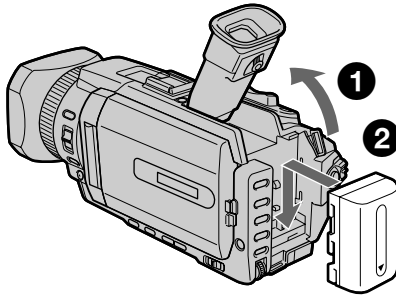

## To remove the battery pack

- (1) Lift up the viewfinder.
- (2) Slide the battery pack out in the direction of the arrow while pressing BATT down.

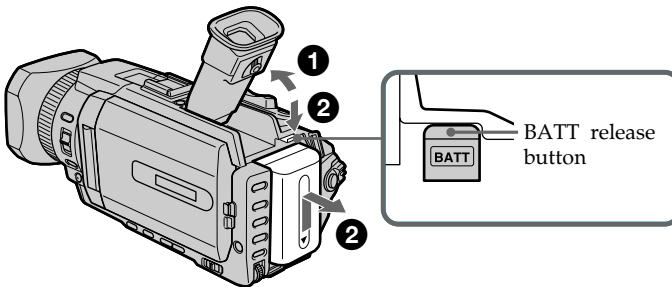

## If you use the large capacity battery pack

If you install the NP-FM70/QM71/FM90/FM91/QM91 battery pack on your camcorder, extend its viewfinder.

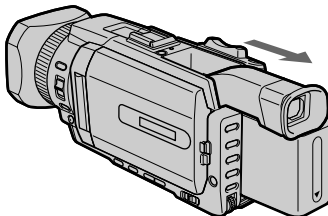

## Step 1 Preparing the power supply

### Charging the battery pack

Use the battery pack after charging it for your camcorder.

Your camcorder operates only with the "InfolITHIUM" battery pack (M series).

See page 231 for details of "InfolITHIUM" battery pack.

- (1) Open the DC IN jack cover and connect the AC power adaptor supplied with your camcorder to the DC IN jack with the plug's ▲ mark facing up.
- (2) Connect the power cord to the AC power adaptor.
- (3) Connect the power cord to the wall outlet.
- (4) Set the POWER switch to OFF (CHG). Charging begins. The remaining battery time is indicated in minutes on the display window.

When the remaining battery indicator changes to , **normal charge** is completed. To fully charge the battery (**full charge**), leave the battery pack attached for about one hour after normal charge is completed until FULL appears in the display window. Fully charging the battery allows you to use the battery longer than usual.

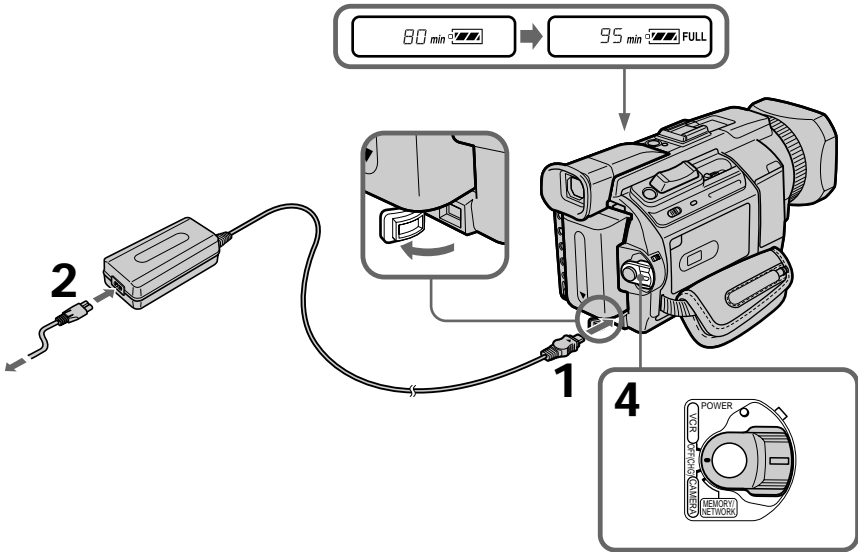

### After charging the battery pack

Disconnect the AC power adaptor from the DC IN jack on your camcorder.



## Step 1 Preparing the power supply

### Note

Prevent metallic objects from coming into contact with the metal parts of the DC plug of the AC power adaptor. This may cause a short-circuit, damaging the AC power adaptor.

### Remaining battery time indicator

The remaining battery time indicator in the display window indicates the approximate recording time with the viewfinder.

### Until your camcorder calculates the actual remaining battery time

“---- min” appears in the display window.

### When you use the AC power adaptor

Place the AC power adaptor near a wall outlet. If any trouble occurs with this unit, disconnect the plug from a wall outlet as soon as possible to cut off the power.

## Charging time

Battery pack	Full charge (Normal charge)
NP-FM50 (supplied)	150 (90)
NP-FM70	240 (180)
NP-QM71	260 (200)
NP-FM90	330 (270)
NP-FM91/QM91	360 (300)

Approximate minutes at 25°C (77°F) to charge an empty battery pack

The charging time may increase if the battery's temperature is extremely high or low because of the ambient temperature.

## Recording time

Battery pack	Recording with the viewfinder		Recording with the LCD screen	
	Continuous	Typical*	Continuous	Typical*
NP-FM50 (supplied)	95	50	75	40
NP-FM70	175	100	135	75
NP-QM71	200	115	155	85
NP-FM90	310	175	240	140
NP-FM91/QM91	360	205	280	160

Approximate minutes when you use a fully charged battery

\* Approximate number of minutes when recording while you repeat recording start/stop, zooming and turning the power on/off. The actual battery life may be shorter.

## Step 1 Preparing the power supply

---

### Playing time

Battery pack	Playing time with LCD closed	Playing time on LCD screen
NP-FM50 (supplied)	180	115
NP-FM70	310	205
NP-QM71	350	235
NP-FM90	550	365
NP-FM91/QM91	635	425

Approximate minutes when you use a fully charged battery

---

### Note

Approximate recording time and playing time at 25°C (77°F). The battery life will be shorter if you use your camcorder in a cold environment.

### If the power goes off although remaining battery time indicator indicates that the battery pack has enough power to operate

Charge the battery pack fully again so that the indication on the battery remaining indicator is correct.

### Recommended charging temperature

We recommend charging the battery pack in an ambient temperature of between 10°C to 30°C (50°F to 86°F).

### What is "InfoLITHIUM"?

The "InfoLITHIUM" is a lithium ion battery pack that can exchange data such as battery consumption with compatible electronic equipment. This unit is compatible with the "InfoLITHIUM" battery pack (M series). Your camcorder operates only with the "InfoLITHIUM" battery. "InfoLITHIUM" M series battery packs have the

 mark.

"InfoLITHIUM" is a trademark of Sony Corporation.

## Step 1 Preparing the power supply

### Connecting to a wall outlet

When you use your camcorder for a long time, we recommend that you power it from a wall outlet using the AC power adaptor.

- (1) Open the DC IN jack cover. Connect the AC power adaptor supplied with your camcorder to the DC IN jack on your camcorder with the plug's ▲ mark facing up.
- (2) Connect the power cord to the AC power adaptor.
- (3) Connect the power cord to a wall outlet.

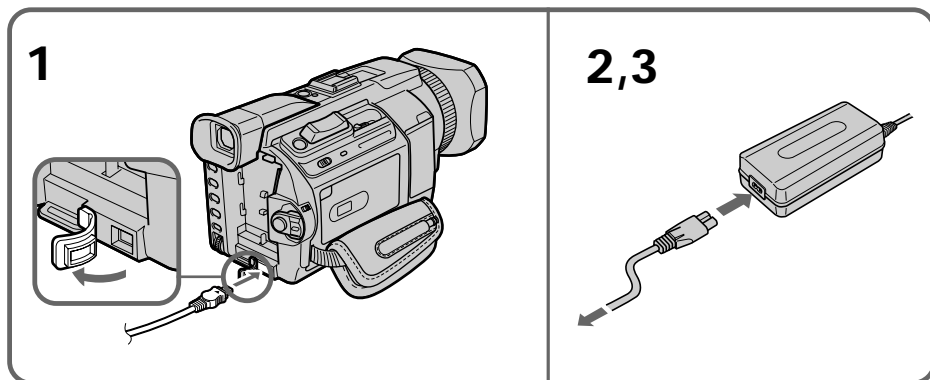

#### PRECAUTION

The set is not disconnected from the AC power supply (house current) as long as it is connected to the wall outlet, even if the set itself has been turned off.

#### Notes

- The AC power adaptor can supply power even if the battery pack is attached to your camcorder.
- The DC IN jack has "source priority." This means that the battery pack cannot supply any power if the power cord is connected to the DC IN jack, even when the power cord is not plugged into a wall outlet.

#### Using a car battery

Use Sony Car Battery Adaptor (optional).

Refer to the operating instructions of the Car Battery Adaptor for further information.



## Step 2 Setting the date and time

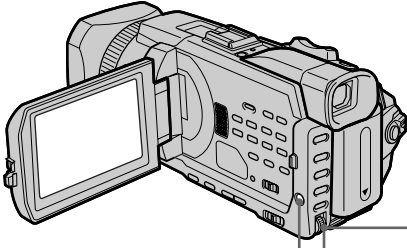

MENU

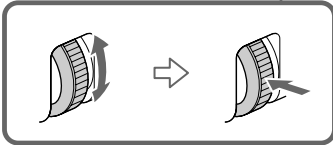

<p><b>2</b></p> <pre> SETUP MENU CLOCK SET USB STREAM LTR SIZE LANGUAGE DEMO MODE [INFO] [RECALL] [RETURN] ETC [MENU]: END         </pre>	<p>→</p> <pre> SETUP MENU [CLOCK SET] STBY USB STREAM LTR SIZE LANGUAGE DEMO MODE [RETURN] ETC [MENU]: END         </pre>
<p><b>3</b></p> <pre> SETUP MENU [CLOCK SET] STBY USB STREAM LTR SIZE LANGUAGE DEMO MODE [RETURN] ETC [MENU]: END         </pre>	<p>→</p> <pre> CLOCK SET AREA 1 GMT +0.0     Lisbon, London DST OFF DATE _ _ _ _ _ _ _ _ [EXEC]: NEXT ITEM         </pre>
<p><b>4</b></p> <pre> CLOCK SET AREA26 GMT -5.0     NewYork, Bogota DST OFF DATE _ Y _ M _ D _ _ _ [EXEC]: NEXT ITEM         </pre>	<p><b>5</b></p> <pre> CLOCK SET AREA26 GMT -5.0     NewYork, Bogota DST OFF DATE _ Y _ M _ D _ _ _ [EXEC]: NEXT ITEM         </pre>
<p><b>6</b></p> <pre> CLOCK SET AREA26 GMT -5.0     NewYork, Bogota DST OFF DATE _ Y _ M _ D _ _ _     2002 JAN 1 12:00AM [EXEC]: NEXT ITEM         </pre>	<p>→</p> <pre> CLOCK SET AREA26 GMT -5.0     NewYork, Bogota DST OFF DATE _ Y _ M _ D _ _ _     2002 JAN 1 12:00AM [EXEC]: NEXT ITEM         </pre>
<p><b>8</b></p> <pre> CLOCK SET AREA26 GMT -5.0     NewYork, Bogota DST OFF DATE _ Y _ M _ D _ _ _     2002 JUL 4 5:30PM [EXEC]: END         </pre>	<p>→</p> <pre> SETUP MENU [CLOCK SET] STBY     JUL 4 2002     5:30:00 PM USB STREAM LTR SIZE LANGUAGE DEMO MODE [RETURN] ETC [MENU]: END         </pre>

Getting Started

### Note

Instead of DST, SUMMERTIME is displayed on the screen for some models.

### If you do not set the date and time

“--:--:--” and “---:---:---” are recorded on the data code of the tape and the “Memory Stick.”

### When using your camcorder abroad

Set the clock to the local time (p. 22).

### If you use the camcorder in a region where daylight saving time is used

Set DST SET to ON in the menu setting.

### Note on the time indicator

The internal clock of your camcorder operates on a 12-hour cycle.

- 12:00 AM stands for midnight.
- 12:00 PM stands for noon.

## Step 2 Setting the date and time

### Simple setting of clock by a time difference

You can easily set the clock to the local time by setting a time difference. Select AREA SET, DST SET\* in the menu settings. See page 216 for more information.

\* Instead of DST, SUMMERTIME is displayed on the screen for some models.

#### World time differences

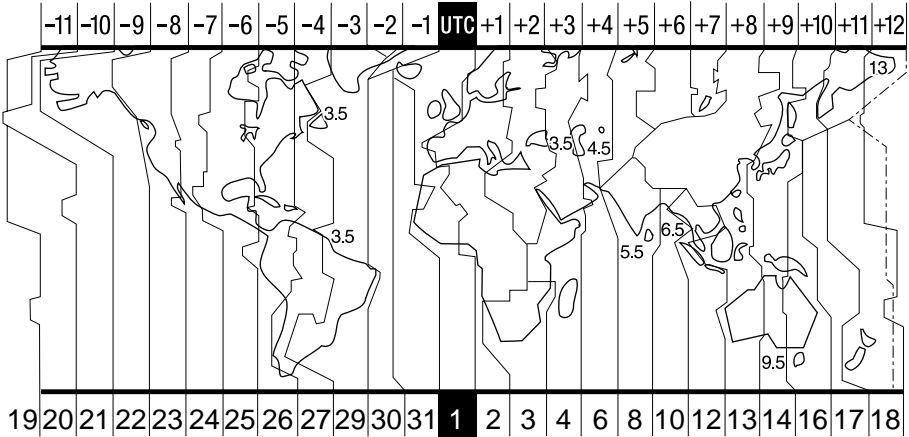

AREA	Time difference	Area or country
1	GMT	Lisbon, London
2	+01:00	Berlin, Paris
3	+02:00	Helsinki, Cairo
4	+03:00	Moscow, Nairobi
5	+03:30	Tehran
6	+04:00	Abu Dhabi, Baku
7	+04:30	Kabul
8	+05:00	Karachi, Islamabad
9	+05:30	Calcutta, New Delhi
10	+06:00	Almaty, Dhaka
11	+06:30	Rangoon
12	+07:00	Bangkok, Jakarta
13	+08:00	Hongkong, Singapore
14	+09:00	Seoul, Tokyo
15	+09:30	Adelaide, Darwin
16	+10:00	Melbourne, Sydney

AREA	Time difference	Area or country
17	+11:00	Solomon Is
18	+12:00	Fiji, Wellington
19	-12:00	Eniwetok, Kwajalein
20	-11:00	Midway Is., Samoa
21	-10:00	Hawaii
22	-09:00	Alaska
23	-08:00	Los Angeles, Tijuana
24	-07:00	Denver, Arizona
25	-06:00	Chicago, Mexico City
26	-05:00	New York, Bogota
27	-04:00	Santiago
28	-03:30	St. John's
29	-03:00	Brasilia, Montevideo
30	-02:00	Fernando de Noronha
31	-01:00	Azores

#### To adjust a time difference

Select AREA SET in the menu setting, and select an area or a country you want to adjust to, then press SEL/PUSH EXEC dial.

## Step 3 Inserting a cassette

- (1) Prepare the power supply.
- (2) Slide  $\square$  OPEN/ $\blacktriangle$  EJECT in the direction of the arrow and open the lid.  
The cassette compartment automatically lifts up and opens.
- (3) Insert the cassette straight as far as possible into the cassette compartment with the window facing out and the write-protect tab facing upward.
- (4) Close the cassette compartment by pressing **PUSH** on the cassette compartment.  
The cassette compartment automatically goes down.
- (5) After the cassette compartment goes down completely, close the lid until it clicks.

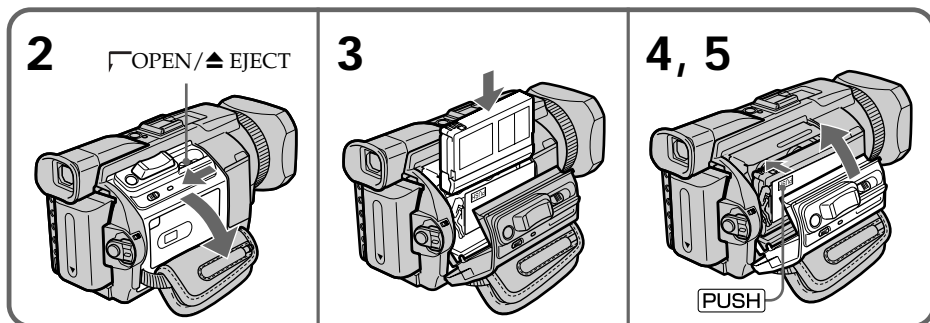

### To eject a cassette

Follow the procedure above, and take out the cassette in step 3.

#### Notes

- Do not press the cassette compartment down forcibly. Doing so may cause a malfunction.
- The cassette compartment may not be closed when you press any part of the cassette compartment other than the **PUSH** mark.

### When you use a cassette with cassette memory

Read the instruction about cassette memory to use this function properly (p. 228).

### To prevent accidental erasure

Slide the write-protect tab on the cassette to expose the red mark.

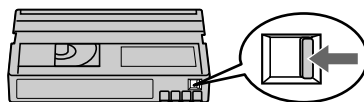

# Step 4 Using the touch panel

Your camcorder has operation buttons on the LCD screen. Touch the LCD screen directly with your finger or the supplied stylus (DCR-TRV950 only) to operate each function. This section describes how to operate the touch panel during recording or playing back images on a tape.

- (1) Prepare the power supply (p. 15 to 19).
- (2) Press OPEN to open the LCD panel.
- (3) Set the POWER switch to CAMERA or VCR while pressing the small green button.
- (4) Press FN. Operation buttons appear on the LCD screen.
- (5) Press PAGE2 to go to PAGE2. Operation buttons appear on the LCD screen.
- (6) Press a desired operation item. Refer to relevant pages of this manual for each function.

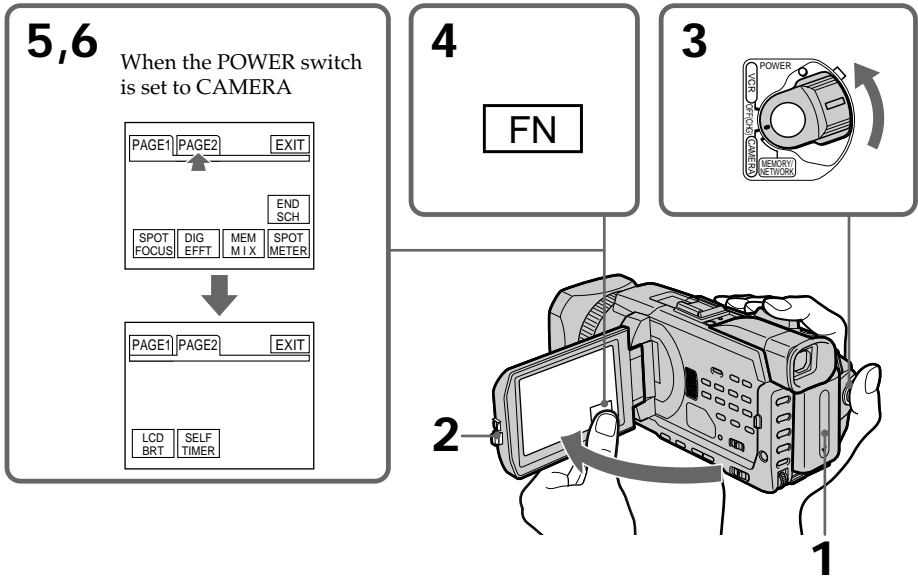

## To return to FN

Press EXIT.

## To execute settings

Press  $\rightarrow$  OK. The display returns to PAGE1/PAGE2.

## To cancel settings

Press  $\rightarrow$  OFF to return to PAGE1/PAGE2.



## Step 4 Using the touch panel

---

### Notes

- When using the touch panel, press operation buttons with your thumb supporting the LCD panel from the back side of it or press those buttons lightly with your index finger.
- Do not press the LCD screen with sharp-pointed objects other than the supplied stylus. (DCR-TRV950 only)
- Do not press the LCD screen too hard.
- Do not touch the LCD screen with wet hands.
- If FN is not on the LCD screen, touch the LCD screen lightly to make it appear. You can control the display with DISPLAY/TOUCH PANEL on your camcorder.
- When operation buttons do not work even if you press them, an adjustment is required (CALIBRATION) (p. 238).
- When the LCD screen gets dirty, clean it with the supplied cleaning cloth.

### When executing each item

The green bar appears above the item.

### If the items are not available

The color of the items changes to gray.

### Press FN to display the following buttons:

When the POWER switch is set to CAMERA

PAGE1	END SCH, SPOT FOCUS, DIG EFFT, MEM MIX, SPOT METER
PAGE2	LCD BRT, SELFTIMER

When the POWER switch is set to VCR

PAGE1	LCD BRT,  PB, INDEX, END SCH
PAGE2	PB ZOOM,  PB, INDEX, DIG EFFT

See page 129 when the POWER switch is set to MEMORY/NETWORK (DCR-TRV950 only).



### Notes

- Fasten the grip strap firmly.
- The recording data (date/time or various settings when recorded) are not displayed while recording. However, they are recorded automatically on the tape. To display the recording data, press the DATA CODE button during playback you can also use the Remote Commander for this operation (p. 41).

### Note on recording

Your camcorder records and plays back in the SP (standard play) mode and in the LP (long play) mode. Select SP or LP in the menu settings (p. 214). In the LP mode, you can record **1.5 times** as long as in the SP mode.

When you record a tape in the LP mode on your camcorder, we recommend playing back the tape on your camcorder.

### Note on the LOCK switch

When you slide the LOCK switch in the direction of the arrow, the POWER switch can no longer be set to MEMORY/NETWORK (DCR-TRV950 only) accidentally. The LOCK switch is set to the further side (unlock position) as the default setting.

### To enable smooth transition

Transition between the last scene you recorded and the next scene is smooth as long as you do not eject the cassette even if you turn off your camcorder.

However, check the following:

- Do not mix recordings in the SP mode and in the LP mode on one tape.
- When you change the battery pack, set the POWER switch to OFF (CHG).
- When you use a cassette with cassette memory, however, you can make the transition smooth even after ejecting the cassette if you use the END SEARCH (p. 37).

### If you leave your camcorder in the standby for five minutes while the cassette is inserted

Your camcorder automatically turns off. This is to save battery power and to prevent battery and tape wear. To return to the standby, set the POWER switch to OFF (CHG) and then back to CAMERA. To start recording, press the START/STOP button again without switching the POWER switch. However, your camcorder does not turn off automatically while the cassette is not inserted.

### When you record in the SP and LP modes on one tape or you record in the LP mode

- The transition between scenes may not be smooth.
- The playback picture may be distorted or the time code may not be written properly between scenes.

### The battery use time when you record using the LCD screen

The battery time is slightly shorter than the shooting time using the viewfinder.

## Recording a picture

---

### After recording

- (1) Set the POWER switch to OFF (CHG).
- (2) Close the LCD panel.
- (3) Eject the cassette.
- (4) Remove the battery pack.

### Adjusting the LCD screen

The LCD panel can be opened up to 90 degrees.

The LCD panel moves about 90 degrees to the viewfinder side and about 180 degrees to the lens side.

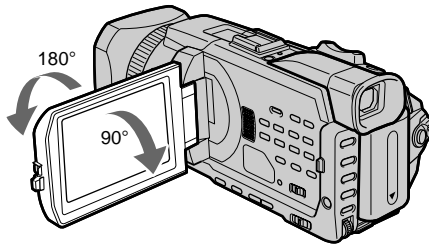

When closing the LCD panel, set it vertically, and swing it into the camcorder body.

---

#### Note

When the LCD panel is opened, the viewfinder automatically turns off and no image is displayed in the viewfinder. However, in the Mirror Mode, images are displayed in the viewfinder as well (p. 32).

#### LCD screen

- When you use the LCD screen outdoors in direct sunlight, the LCD screen may be difficult to see. If this happens, we recommend that you use the viewfinder.
- When you adjust the angle of the LCD panel, make sure if the LCD panel is opened up to 90 degrees.

## Recording a picture

### Adjusting the brightness of the LCD screen

- (1) Press FN and select PAGE2 while the POWER switch is set to CAMERA or MEMORY/NETWORK (DCR-TRV950 only).  
When you set the POWER switch to VCR, press FN to display PAGE1.
- (2) Press LCD BRT. The screen to adjust the brightness of the LCD screen appears.
- (3) Adjust the brightness of the LCD screen using -/+.
  - : to dim
  - + : to brighten
- (4) Press  $\Rightarrow$  OK to return to PAGE1/PAGE2.

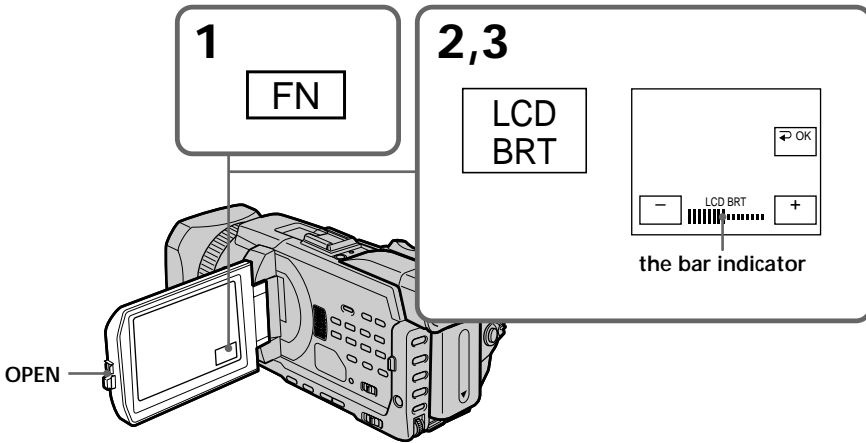

#### To return to FN

Press EXIT.

#### LCD screen backlight

You can change the brightness of the backlight. Select LCD B.L. in the menu settings when using the battery pack (p. 210).

#### Even if you adjust LCD BRT

The recorded picture will not be affected.

## Recording a picture

---

### Adjusting the viewfinder

If you record pictures with the LCD panel closed, check the picture with the viewfinder. Adjust the viewfinder lens to your eyesight so that the images in the viewfinder come into sharp focus.

Lift up the viewfinder and move the viewfinder lens adjustment lever.

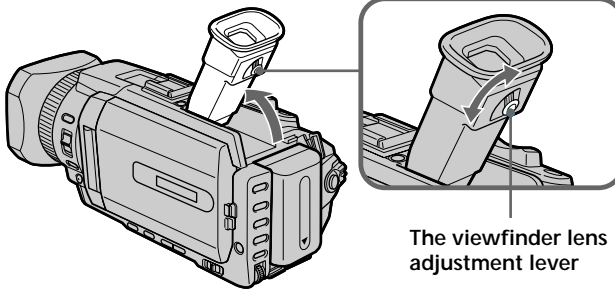

---

### Viewfinder backlight

You can change the brightness of the backlight. Select VF B.L. in the menu settings when using the battery pack (p. 210).

## Recording a picture

### Using the zoom feature

Move the power zoom lever a little for a slower zoom. Move it further for a faster zoom. Using the zoom sparingly results in better-looking recordings.

W : Wide-angle (subject appears farther away)

T : Telephoto (subject appears closer)

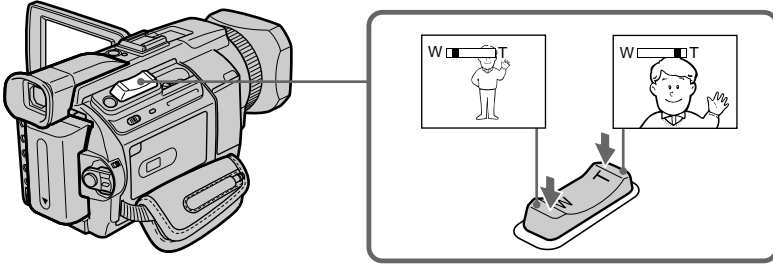

#### To use zoom greater than 12x

Zoom greater than 12x is performed digitally. Digital zoom can be set to 24x or 150x.

To activate digital zoom, select the digital zoom power in D ZOOM in the menu settings (p. 209). The digital zoom is set to OFF as a default setting.

The right side of the bar shows the digital zooming zone.

The digital zooming zone appears when you select the digital zoom power in the menu settings.

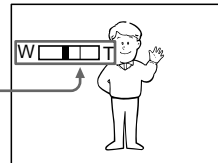

#### When you shoot close to a subject

If you cannot get a sharp focus, move the power zoom lever to the “W” side until the focus is sharp. You can shoot a subject that is at least about 80 cm (about 2 feet 5/8 inch) away from the lens surface in the telephoto position, or about 1 cm (about 1/2 inch) away in the wide-angle position.

#### Note on digital zoom

The picture quality deteriorates as you move the power zoom lever towards the “T” side.

#### When the POWER switch is set to MEMORY/NETWORK (DCR-TRV950 only)

You cannot use the digital zoom.

## Recording a picture

---

### Shooting with the Mirror Mode

This feature allows the camera subject to view him-or herself on the LCD screen. The subject uses this feature to check his or her own image on the LCD screen while you look at the subject in the viewfinder.

Set the POWER switch to CAMERA or MEMORY/NETWORK (DCR-TRV950 only).

**Rotate the LCD screen 180 degrees.**

The ☺ indicator appears in the viewfinder and on the LCD screen.

⦿ appears in the standby, and ● appears in the recording while the POWER switch is set to CAMERA. Some of other indicators appear mirror-reversed and others are not displayed.

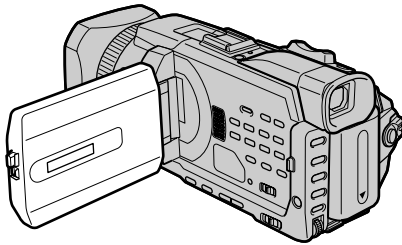

---

#### Picture in the mirror mode

The picture on the LCD screen is a mirror-image. However, the picture will be normal when recorded.

#### During recording in the mirror mode

- ZERO SET MEMORY on the Remote Commander does not work.
- FN appears mirror-reversed in the viewfinder.

#### When you press FN

The ☺ does not appear on the screen.



### Indicators displayed in the recording

Indicators are not recorded on tapes.

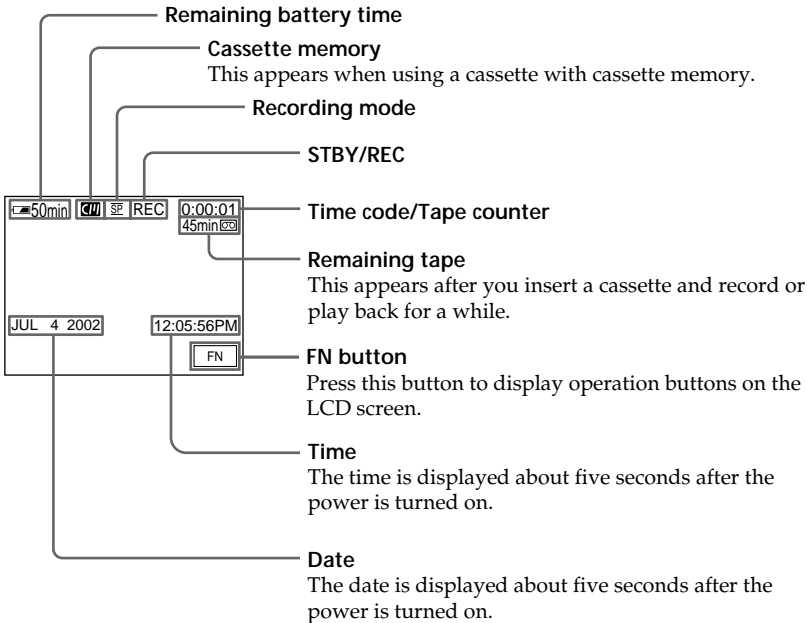

#### Remaining battery time indicator during recording

The remaining battery time indicator roughly indicates the continuous recording time. The indicator may not be correct, depending on the conditions in which you are recording. When you close the LCD panel and open it again, it takes about one minute for the correct remaining battery time in minutes to be displayed.

#### Time code

The time code indicates the recording or playback time, "0:00:00" (hours : minutes : seconds) in CAMERA and "0:00:00:00" (hours : minutes : seconds : frames) in VCR. You cannot rewrite only the time code.

#### Remaining tape indicator

The indicator may not be displayed accurately depending on the tape.

#### Recording data

The recording data (date/time or various settings when recorded) are not displayed while recording. However, they are recorded automatically on the tape. To display the recording data, press the DATA CODE button during playback. You can also use the Remote Commander for this operation (p. 41).

## Recording a picture

---

### Shooting backlit subjects – BACK LIGHT

When you shoot a subject with the light source behind the subject or a subject with a light background, use the backlight function.

Press BACK LIGHT while the POWER switch is set to CAMERA or MEMORY / NETWORK (DCR-TRV950 only).

The  indicator appears on the screen. To cancel, press BACK LIGHT again.

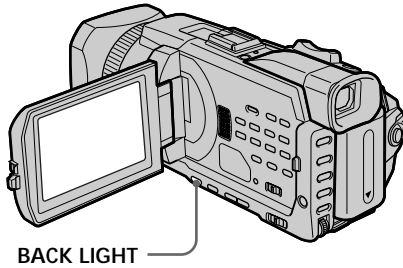

---

#### When shooting backlit subjects

If you press SPOT LIGHT, EXPOSURE or SPOT METER, the backlight function will be canceled.

#### When you manually adjust the exposure

You cannot use the backlight function.

### Shooting subjects lit by strong light – SPOT LIGHT

This function prevents people's faces, for example, from appearing excessively white when shooting subjects lit by strong light, such as in the theater.

Press SPOT LIGHT while the POWER switch is set to CAMERA or MEMORY / NETWORK (DCR-TRV950 only).

The  indicator appears on the screen. To cancel, press SPOT LIGHT again.

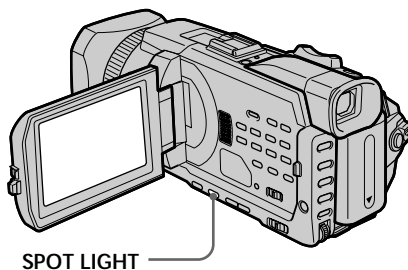

---

#### when shooting spotlighted subjects

If you press BACK LIGHT, EXPOSURE or SPOT METER, the spot light function will be canceled.

#### When you manually adjust the exposure

You cannot use the spot light function.

## Recording a picture

### Self-timer recording

Recording with the self-timer starts in 10 seconds automatically. You can also use the Remote Commander for this operation.

(1) In the standby, press FN and select PAGE2.

(2) Press SELFTIMER.

The  (self-timer) indicator appears on the screen.

(3) Press START/STOP.

The self-timer starts counting down from 10 with a beep. In the last two seconds of the countdown, the beep gets faster, then recording starts automatically.

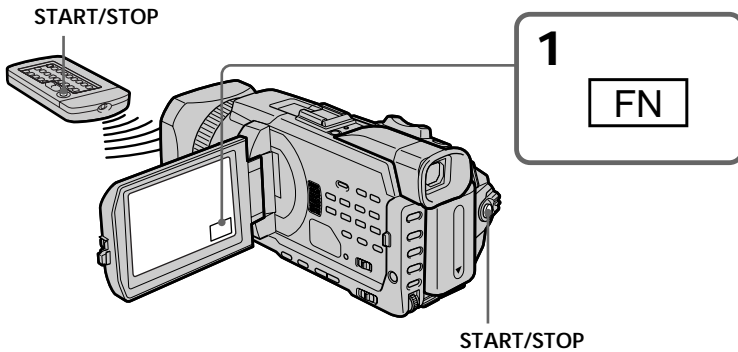

#### To stop the count down

Press START/STOP.

To restart the countdown, press START/STOP again.

#### To cancel the self-timer

Press SELFTIMER so that the  (self-timer) indicator disappears from the screen while your camcorder is in the standby.

---

#### Note

The self-timer is automatically canceled when:

- The self-timer recording is finished.
- The POWER switch is set to OFF (CHG) or VCR.

#### When the POWER switch is set to MEMORY/NETWORK (DCR-TRV950 only)

You can also record still images on a "Memory Stick" with the self-timer (p. 143).

# Checking recordings

## – END SEARCH / EDITSEARCH / Rec Review

You can use these buttons to check the recorded picture or shoot so that the transition between the last recorded scene and the next scene you record is smooth.

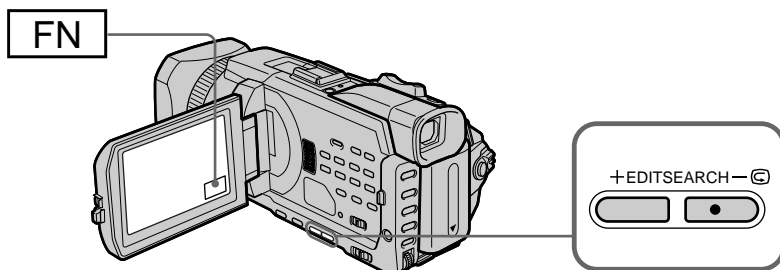

### END SEARCH

You can go to the end of the recorded section after you record.

- (1) In the standby, press FN to display PAGE1.
- (2) Press END SCH.

The last five seconds of the recorded section are played back and your camcorder returns to the standby. You can monitor the sound from the speaker or headphones.

#### To return to FN

Press EXIT.

#### To stop searching

Press END SCH again.

---

#### End search

When you use a cassette without cassette memory, the end search function does not work once you eject the cassette after you have recorded on the tape. If you use a cassette with cassette memory, the end search works even once you eject the cassette.

#### If a tape has a blank portion between recorded portions

The end search may not work correctly.

### EDITSEARCH

You can search for the next recording start point.

Hold down the EDITSEARCH in the standby. The recorded portion is played back.

- [C] : To go backward
- + : To go forward

Release EDITSEARCH to stop playback. If you press START/STOP, recording begins from the point you released EDITSEARCH. You cannot monitor the sound.

### Rec Review

You can check the last recorded section.

Press the –  side of EDITSEARCH momentarily in the standby.

The section you have stopped most recently will be played back for a few seconds, and then your camcorder will return to the standby. You can monitor the sound from the speaker or headphones.

# Playing back a tape

You can monitor the playback picture on the screen. If you close the LCD panel, you can monitor the playback picture in the viewfinder. You can control playback using the Remote Commander supplied with your camcorder.

- (1) Prepare the power supply and insert the recorded tape.
- (2) Set the POWER switch to VCR while pressing the small green button.
- (3) Open the LCD panel while pressing OPEN.
- (4) Press ◀◀ to rewind the tape.
- (5) Press ▶▶ to start playback.
- (6) To adjust the volume, press either of the two buttons on VOLUME.  
- : To turn down  
+ : To turn up

When you close the LCD panel, sound is muted.

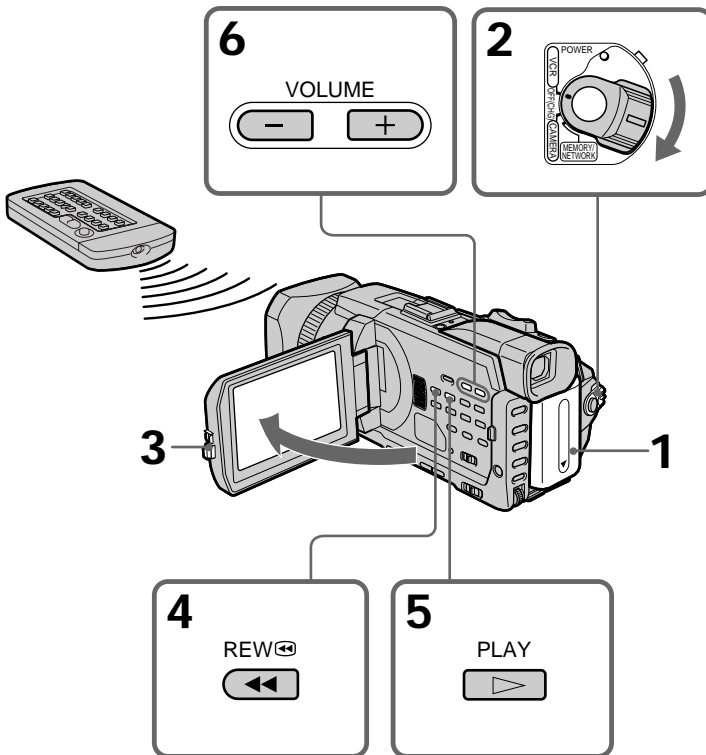

## To stop playback

Press ■.

## Playing back a tape

---

### When monitoring on the LCD screen

You can turn the LCD panel over and move it back to the camcorder body with the LCD screen facing out.

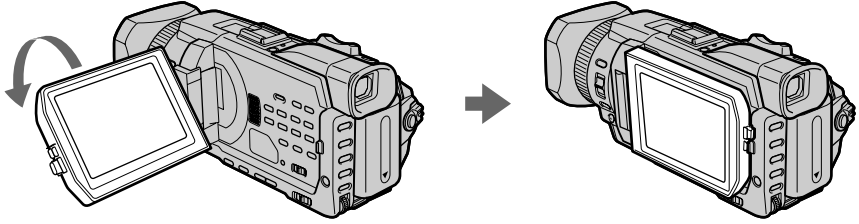

### If you leave the power on for a long time

Your camcorder gets warm. This is not a malfunction.

### When you open or close the LCD panel

Make sure that the LCD panel is set vertically.



## Playing back a tape

### To display the screen indicators – Display function

Press DISPLAY/TOUCH PANEL on your camcorder or DISPLAY on the Remote Commander supplied with your camcorder. The indicators disappear on the screen. To make the indicators appear, press DISPLAY/TOUCH PANEL or DISPLAY again.

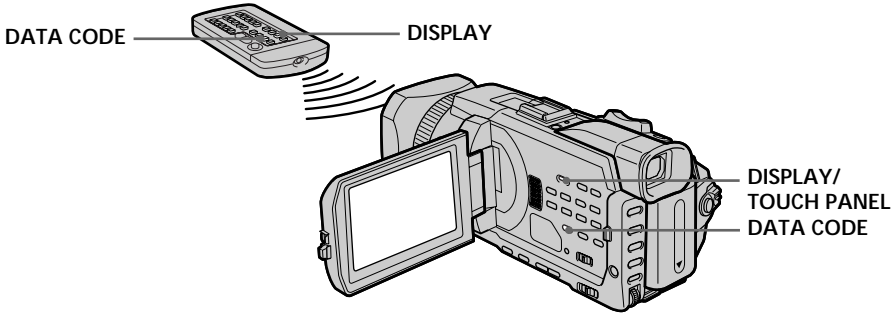

### About date/time and various settings

Your camcorder automatically records not only images on the tape but also the recording data (date/time or various settings when recorded) (**data code**).

- ① Set the POWER switch to VCR, then play back a tape.
- ② Press DATA CODE on your camcorder or the Remote Commander.

The display changes as follows when you press the DATA CODE:  
date/time → various settings (SteadyShot, exposure, white balance, gain, shutter speed, aperture value) → no indicator

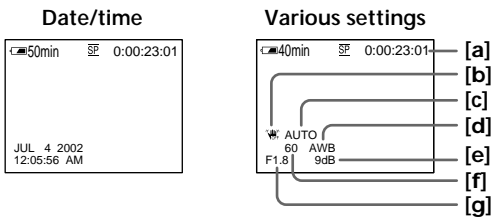

- [a] Tape counter
- [b] SteadyShot OFF
- [c] Exposure mode
- [d] White balance
- [e] Gain
- [f] Shutter speed
- [g] Aperture value

## Playing back a tape

---

### To not display various settings

Set DATA CODE to DATE in the menu settings (p. 216).

The display changes as follows when you press DATA CODE :  
date/time ↔ no indicator

---

### Various settings

Various settings are your camcorder's information when you have recorded. In the recording, the various settings will not be displayed.

### When you use the data code, bars (-- --) appear if:

- A blank portion of the tape is being played back.
- The tape is unreadable due to tape damage or noise.
- The tape was recorded by a camcorder without the date and time set.

### Data code

When you connect your camcorder to the TV, the data code appears on the TV screen.

### Remaining battery time indicator during playback

The indicator indicates the approximate continuous playback time. The indicator may not be correct, depending on the conditions in which you are playing back. When you close the LCD panel and open it again, it takes about one minute for the correct remaining battery time to be displayed.

### Various playback modes

To operate video control buttons, set the POWER switch to VCR.

#### **To play back pause (viewing a still picture)**

Press **II** during playback. To resume normal playback, press **▶** or **II**.

#### **To advance the tape**

Press **▶▶** in the stop mode. To resume normal playback, press **▶**.

#### **To rewind the tape**

Press **◀◀** in the stop mode. To resume normal playback, press **▶**.

#### **To change the playback direction**

Press **<** on the Remote Commander during playback to reverse the playback direction. To resume normal playback, press **▶**.

#### **To locate a scene monitoring the picture (picture search)**

Keep pressing **◀◀** or **▶▶** during playback. To resume normal playback, release the button.

#### **To monitor high-speed pictures while advancing or rewinding the tape (skip scan)**

Keep pressing **◀◀** while rewinding or **▶▶** while advancing the tape. To resume rewinding or advancing, release the button.

#### **To view the picture at slow speed (slow playback)**

Press **▶▶** on the Remote Commander during playback. For slow playback in the reverse direction, press **<**, then press **▶▶** on the Remote Commander. To resume normal playback, press **▶**.

#### **To view pictures at double speed**

Press **×2** on the Remote Commander during playback. For double speed playback in the reverse direction, press **<**, then press **×2** on the Remote Commander. To resume normal playback, press **▶**.

#### **To view pictures frame-by-frame**

Press **II▶** on the Remote Commander in the playback pause. For frame-by-frame playback in the reverse direction, press **◀II**. To resume normal playback, press **▶**.

#### **To search the last scene recorded (END SEARCH)**

Press **FN**, then press **END SCH** in the stop mode. The last five-second recorded portion is played back and then stopped.

## Playing back a tape

---

### In the various playback modes

- Sound is muted.
- The previous picture may remain as a mosaic image during playback.

### When the playback pause lasts for five minutes

Your camcorder automatically enters the stop mode. To resume playback, press ►.

### Slow playback

The slow playback can be performed smoothly on your camcorder. However, this function does not work for an output signal through the  DV Interface.

### When you play back a tape in reverse

Horizontal noise may appear at the center, or the top and bottom of the screen. This is not a malfunction.

# Viewing the recording on TV

Connect your camcorder to your TV with the A/V connecting cable supplied with your camcorder to watch playback picture on the TV screen. You can operate the video control buttons in the same way as when you monitor playback pictures on the screen. When monitoring playback pictures on the TV screen, we recommend that you power your camcorder from a wall outlet using the AC power adaptor (p. 19). Refer to the operating instructions of your TV.

Open the jack cover. Connect your camcorder to the TV with the A/V connecting cable supplied with your camcorder. Then, set the TV/VCR selector on the TV to VCR.

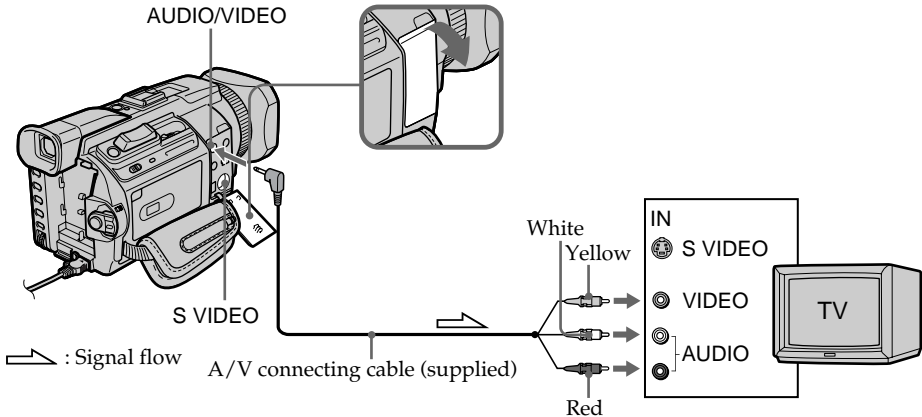

## If your TV is already connected to a VCR

Connect your camcorder to the LINE IN input on the VCR by using the A/V connecting cable supplied with your camcorder. Set the input selector on the VCR to LINE.

## If your TV or VCR is a monaural type

Connect the yellow plug of the A/V connecting cable to the video input jack and the white or the red plug to the audio input jack on the VCR or the TV. If you connect the white plug, the sound is L (left) signal. If you connect the red plug, the sound is R (right) signal.

### If your TV has an S video jack

Pictures can be reproduced more faithfully by using an S video cable (optional). With this connection, you do not need to connect the yellow (video) plug of the A/V connecting cable. Connect the S video cable (optional) to the S video jacks on both your camcorder and the TV.

This connection produces higher quality DV format pictures.

### To display the screen indicators on TV

Set DISPLAY to V-OUT/LCD in the menu settings (p. 217).

Then, press DISPLAY/TOUCH PANEL on your camcorder. To turn the screen indicators off, press DISPLAY/TOUCH PANEL on your camcorder again.

# Recording still images on a “Memory Stick” during tape recording

You can record still images on a “Memory Stick” in the tape recording or tape recording standby. You can also record still images on a tape (p. 51).

## Before operation

- Insert a “Memory Stick” into your camcorder.
- Set PHOTO REC in  to MEMORY in the menu settings (The default setting is MEMORY).

- (1) In the standby, keep pressing PHOTO lightly until a still image appears. The CAPTURE indicator appears. Recording does not start yet. To change from the selected still image to another image, release PHOTO once and press it lightly again.
- (2) Press PHOTO deeper.  
Recording is complete when the bar scroll indicator disappears.  
The image while pressing the button deeply is recorded on the “Memory Stick.”

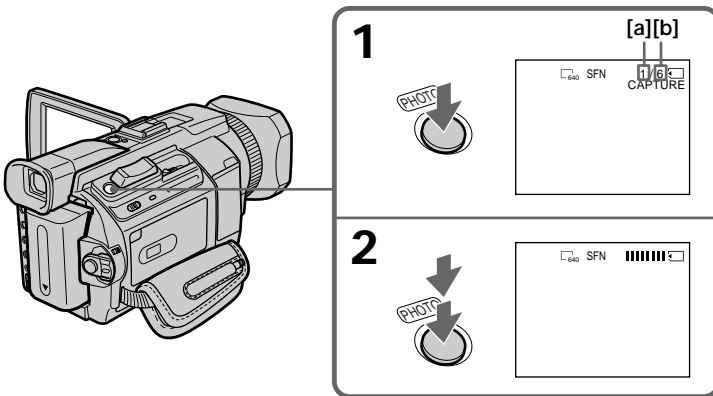

[a] : Number of the recorded images

[b] : Approximate number of the images that can be recorded on the “Memory Stick”

## Notes

- When recording a still image, do not shake your camcorder. If you do so, the image may flutter.
- You cannot record still images on a “Memory Stick” during following operations (The  indicator flashes on the screen.):
  - Wide mode
  - Fader
  - Picture effect
  - Digital effect
  - MEMORY MIX

## “Memory Stick”

For details, see page 126 for more information.

## Recording still images on a “Memory Stick” during tape recording

---

### **Image size of still images**

Image size is automatically set to 640 × 480.

When you want to record still images in different size, use the Memory Photo recording (p. 135).

### **When the POWER switch is set to CAMERA**

You cannot select image quality.

The image quality when you set the POWER switch to MEMORY/NETWORK (DCR-TRV950 only) is used. (The default setting is SUPER FINE).

### **During and after recording still images on a “Memory Stick”**

Your camcorder continues recording on tape.

### **When you press PHOTO on the Remote Commander**

Your camcorder immediately records the image that is on the screen when you press the button.

### **To record still images on a “Memory Stick” during tape recording**

You cannot check an image on the screen by pressing PHOTO lightly. The image when you press PHOTO will be recorded on the “Memory Stick.”

### **To record images with higher quality**

We recommend that you use the Memory Photo recording (p. 135).

### **Title**

The title cannot be recorded.

## Recording still images on a “Memory Stick” during tape recording

### Recording images with the flash

The flash pops up automatically. The default setting is auto (no indicator). To change the flash mode, press **⚡** (flash) repeatedly until the flash mode indicator appears on the screen.

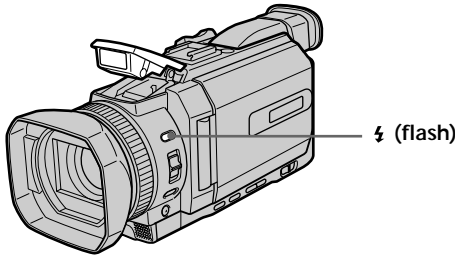

Each press of **⚡** (flash) changes the indicator as follows:

- → **⚡** → **⚡** → (no indicator)
- Auto red-eye reduction: The flash fires before recording to reduce red-eye.
- ⚡** Forced flash: The flash fires regardless of the surrounding brightness.
- ⚡** No flash: The flash does not fire.

The flash is automatically adjusted to the appropriate brightness. You can also change FLASH LVL to the desired brightness in the menu settings (p. 208). Try recording various images to find the most appropriate setting for FLASH LVL.

#### Notes

- Attaching the lens hood or a conversion lens (optional) may block the light from the flash or cause lens shadow to appear.
- You cannot use an external flash (optional) and the built-in flash at the same time.
- ● (auto red-eye reduction) may not produce the desired effect depending on individual differences, the distance to the subject, the subject not looking at the pre-recording flash or other conditions.
- A flash effect cannot be obtained easily when you use forced flash in a bright location.
- When recording with the flash, it takes longer to prepare for image capture. This is because your camcorder starts to charge power for firing after the flash pops up. Darken the surroundings by covering the lens, and press PHOTO lightly so that your camcorder starts to charge power after the flash pops up.
- If it is not easy to focus on the subject automatically, for example, when recording in the dark, use the focal distance information (p. 77) for focusing manually.

#### When the flashlight does not reach to the subject

The color of the image may change.

#### If you leave your camcorder for five or more minutes after removing the power supply

Your camcorder returns to the default setting (auto).



## Recording still images on a “Memory Stick” during tape recording

---

You cannot shoot images with the flash during the following operations:

- Tape Recording
- Shutter speed (1/30 or smaller) adjustment

The flash does not fire even if you select auto (no indicator) and  (auto red-eye reduction) during the following operations:

- Spot light
- Shutter speed adjustment
- Sunset & moon of PROGRAM AE
- Landscape of PROGRAM AE
- Exposure
- Flexible Spot Meter

**When you use an external flash (optional) which does not have the auto red-eye reduction**

You cannot select the auto red-eye reduction.

# Recording still images on a “Memory Stick” during tape recording

## Self-timer recording

You can record still images on a “Memory Stick” with the self-timer. You can also use the Remote Commander for this operation.

### Before operation

- Insert a “Memory Stick” into your camcorder.
- Set PHOTO REC in  to MEMORY in the menu settings. (The default setting is MEMORY.)

(1) In the standby, press FN and select PAGE2.

(2) Press SELFTIMER.

The  (self-timer) indicator appears on the screen.

(3) Press PHOTO deeper.

The self-timer starts counting down from 10 with a beep. In the last two seconds of the countdown, the beep gets faster, then the recording starts automatically.

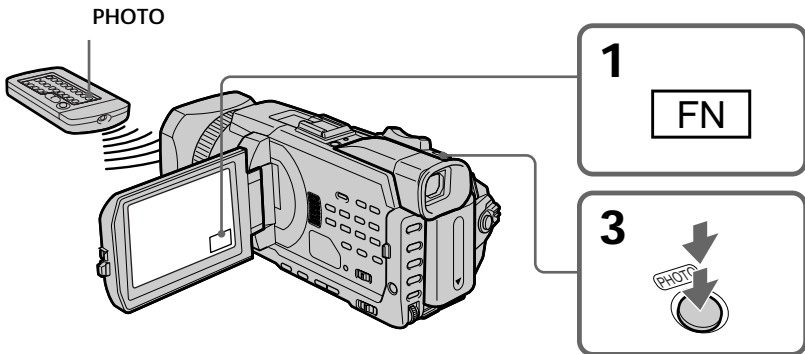

### To cancel the self-timer

Press SELFTIMER so that the  (self-timer) indicator disappears from the screen while your camcorder is in the standby. You cannot stop the count down.

---

### Note

The self-timer is automatically canceled when:

- The self-timer is finished.
- The POWER switch is set to OFF (CHG) or VCR.

### Self-timer recording

You can operate the self-timer recording only during the recording standby.

# Recording still images on a tape

## - Tape Photo recording

You can record still images such as photographs on tapes.

You can record about 510 images in the SP mode and about 765 images in the LP mode on a 60-minute tape.

- (1) In the standby, set PHOTO REC in  to TAPE in the menu settings.
- (2) Keep pressing PHOTO lightly until a still image appears.  
The CAPTURE indicator appears. Recording does not start yet.  
To change from the selected still image to another image, release PHOTO once and press it lightly again.
- (3) Press PHOTO deeper.  
The still image on the screen is recorded for about seven seconds. The sound during those seven seconds is also recorded.  
The still image is displayed on the screen until recording is completed.

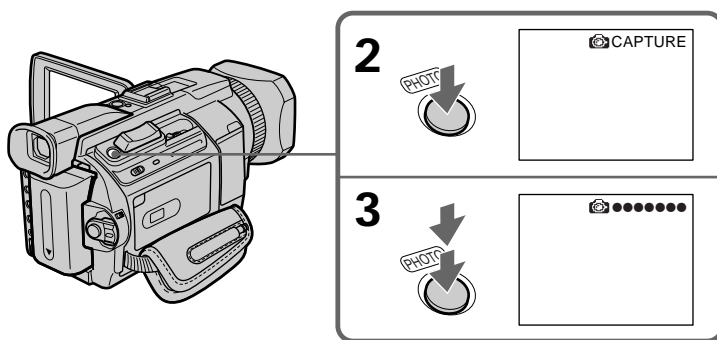

### Recording images with the flash

For the details, see page 48.

### Recording images with self-timer

- (1) Set PHOTO REC in  to TAPE in the menu settings (p. 209).
- (2) Follow steps 1 and 3 on page 50.

## Recording still images on a tape – Tape Photo recording

---

### Notes

- During tape photo recording, you cannot change the mode or setting.
- When recording a still image, do not shake your camcorder. If you do so, the image may flutter.
- You cannot use PHOTO during the following operations: (The  indicator flashes on the screen.)
  - Fader
  - Digital effect
- When you record images with the flash, sound may not be recorded clearly.

### If you record a moving subject with the tape photo recording

When you play back the still image on other equipment, the image may flutter. This is not a malfunction.

### When you press PHOTO on the Remote Commander

Your camcorder immediately records the image that is on the screen when you press the button.

### To use the tape photo recording during the tape recording

You cannot check an image on the screen by pressing PHOTO lightly. Press PHOTO deeper. The still image is then recorded for about seven seconds, and your camcorder returns to the standby.

### To record clear still images with little unsteadiness

We recommend that you record on a “Memory Stick” using the Memory Photo recording.

### When you record images with the flash

The allowed shooting distance is shorter than when you record on a “Memory Stick” in Memory Photo recording.

### When playing back images recorded with the flash on other equipment

These images may flicker.

# Using the wide mode

You can record a 16:9 wide picture to watch on a 16:9 wide-screen TV (16:9WIDE). If you connect a TV compatible with the ID-1/ID-2 system, the screen size is automatically selected.

Black bands appear on the screen during recording in 16:9WIDE mode [a]. The picture during playback on a normal TV [b] or on a wide-screen TV [c] is compressed in the longwise direction. If you set the screen mode of the wide-screen TV to the full mode, you can watch pictures of normal images [d].

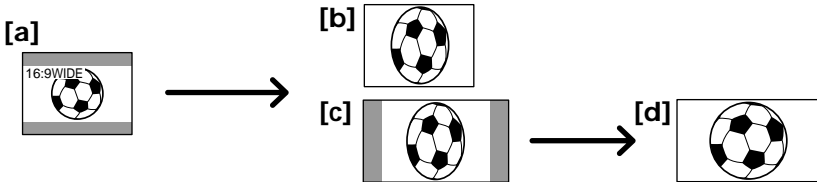

- (1) In the standby, press MENU, then turn the SEL/PUSH EXEC dial to select 16:9WIDE in , then press the dial (p. 209).
- (2) Turn the SEL/PUSH EXEC dial to select ON, then press the dial.

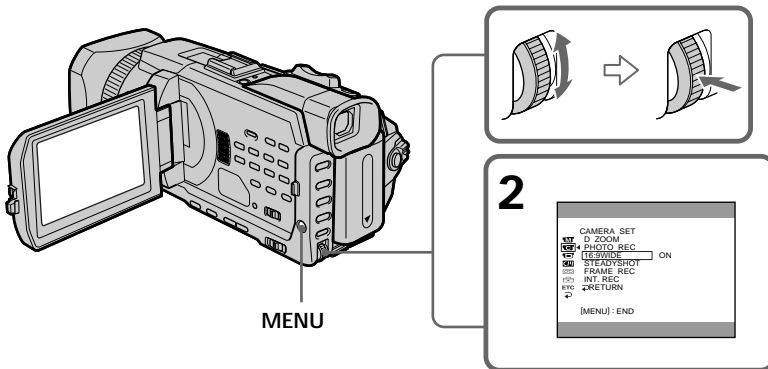

## To cancel the wide mode

Set 16:9WIDE to OFF in the menu settings.

## Using the wide mode

---

### **In the wide mode**

You cannot select the following functions:

- Recording still images on a "Memory Stick" in the tape recording or recording standby
- BOUNCE
- OLD MOVIE

### **During recording**

You cannot select or cancel the wide mode. When you cancel the wide mode, set your camcorder to the standby and then set 16:9WIDE to OFF in the menu settings.

### **Connection for a TV**

Pictures recorded in the 16:9WIDE mode automatically appear on the TV screen at full size when:

- You connect your camcorder to a TV that is compatible with the video ID (ID-1/ID-2) system.
- You connect your camcorder to the S video jack on the TV.

### **ID-1 system**

The ID-1 system sends aspect ratio (screen horizontal/vertical ratio) information (16:9, 4:3, or letter box) with video signals.

### **ID-2 system**

The ID-2 system sends a copyright protection signal with ID-1 signals inserted between video signals when you connect your camcorder to other equipment using an A/V connecting cable.

# Using the fader

You can fade in or out to give your recording a more professional appearance.

[a] STBY REC

FADER

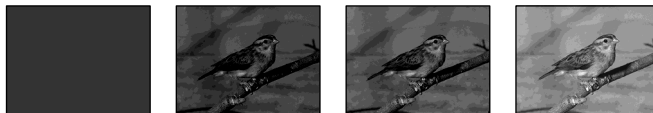

M. FADER  
(mosaic)



BOUNCE<sup>1) 2)</sup>

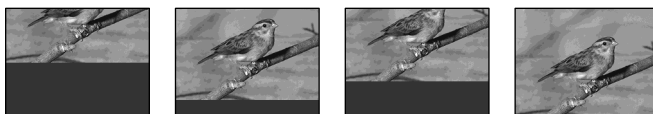

OVERLAP<sup>2)</sup>



WIPE<sup>2)</sup>

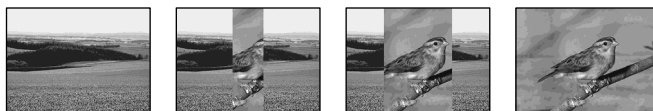

DOT<sup>2)</sup>

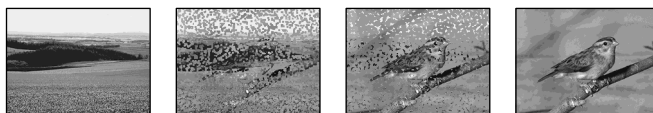

[b] STBY REC

## MONOTONE

When fading in, the picture gradually changes from black-and-white to color.  
When fading out, the picture gradually changes from color to black-and-white.

<sup>1)</sup> You can use the bounce when D ZOOM is set to OFF in the menu settings.

<sup>2)</sup> Fade in only.

## Using the fader

### (1) When fading in [a]

In the standby, press FADER until the desired fader indicator flashes.

### When fading out [b]

In the recording, press FADER until the desired fader indicator flashes.

The indicator changes as follows:

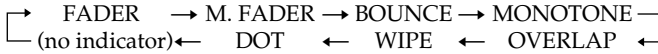

The last selected fader is indicated first of all.

### (2) Press START/STOP. The fader indicator stops flashing.

After fade in/out ends, your camcorder automatically returns to the normal mode.

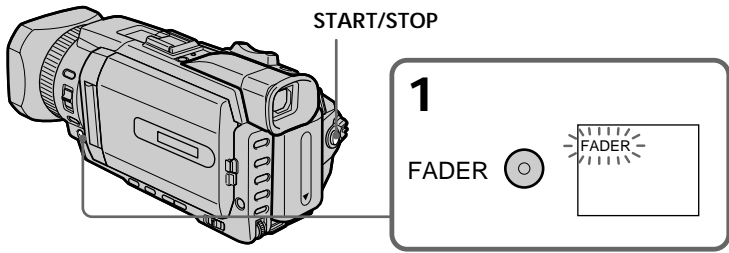

### To cancel the fader

Before pressing START/STOP, press FADER until the indicator disappears.

#### Note

You cannot use the following functions while using the fader. Also, you cannot use the fader while using the following functions:

- Recording still images on a "Memory Stick" in the tape recording or recording standby
- Tape photo recording
- Digital effect
- Interval recording
- Frame recording

### When you select OVERLAP, WIPE, or DOT

Your camcorder automatically stores the image recorded on a tape. While the image is being stored, the indicators flash fast, and the playback picture disappears. At this stage, the picture may not be recorded clearly, depending on the tape condition.



## Using the fader

---

When you set the POWER switch to MEMORY/NETWORK (DCR-TRV950 only)

You cannot use the fader.

While using BOUNCE, you cannot use the following functions:

- Zoom
- Picture effect
- Shutter speed adjustment
- Exposure
- Flexible Spot meter
- Focus manually
- Spot Focus

### Note on BOUNCE

The BOUNCE indicator does not appear in the following mode or functions:

- When D ZOOM is activated in the menu settings
- Wide mode
- Picture effect
- PROGRAM AE

# Using special effects – Picture effect

You can digitally process images to obtain special effects like those in films or on TV.

**NEG. ART [a]** : The color and brightness of the picture are reversed.

**SEPIA** : The picture appears in sepia.

**B&W** : The picture appears in monochrome (black-and-white).

**SOLARIZE [b]** : The light intensity becomes clearer, to make the picture look more like an illustration.

**SLIM [c]** : The picture expands vertically.

**STRETCH [d]** : The picture expands horizontally.

**MOSAIC [e]** : The picture appears mosaic-patterned.

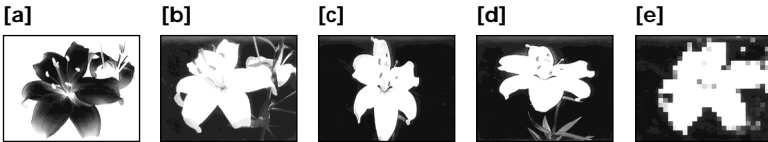

(1) Set the POWER switch to CAMERA. Press MENU, then select P EFFECT in  with the SEL/PUSH EXEC dial, then press the dial (p. 208).

(2) Turn the SEL/PUSH EXEC dial to select the desired mode, then press the dial.

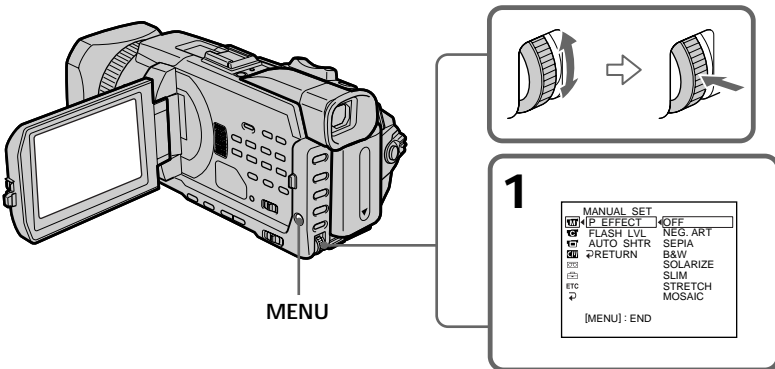

## To cancel the picture effect

Set P EFFECT to OFF in the menu settings.

### Note

The following functions do not work during the picture effect

- Recording still images on a "Memory Stick" in the tape recording or recording standby
- BOUNCE
- OLD MOVIE

When you set the POWER switch to OFF (CHG)

Picture effect is automatically canceled.

# Using special effects – Digital effect

You can add special effects to recorded pictures using the various digital functions. Sound is recorded normally.

## STILL

You can record a still image so that it is superimposed on a moving picture.

## FLASH (FLASH MOTION)

You can record still images successively at constant intervals.

## LUMI. (LUMINANCEKEY)

You can swap a brighter area in a still image with a moving picture.

## TRAIL

You can record the picture so that an incidental image like a trail is left.

## OLD MOVIE

You can add an old movie type atmosphere to pictures. Your camcorder automatically sets the wide mode to ON and picture effect to SEPIA, and sets the appropriate shutter speed.

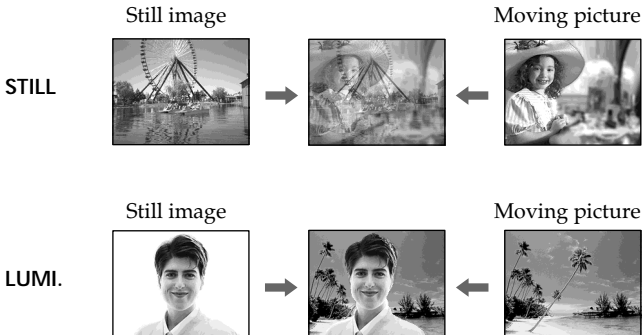

## Using special effects – Digital effect

- (1) Press FN to display PAGE1 while the POWER switch is set to CAMERA.
- (2) Press DIG EFFT. The screen to select a desired digital effect appears.
- (3) Press a desired mode. In the STILL and LUMI. modes, the still image is stored in memory.
- (4) Press -/+ to adjust the effect.  
 -: To reduce the effect  
 +: To increase the effect

### Items to be adjusted

STILL	The rate of the still image you want to superimpose on the moving picture
FLASH	The interval of frame by frame playback
LUMI.	The color scheme of the area in the still image which is to be swapped with a moving picture
TRAIL	The vanishing time of the incidental image
OLD MOVIE	No adjustment necessary

- (5) Press ↻ OK to return to PAGE1.

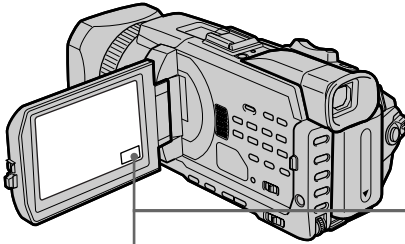

**1**

FN

**2~4**

DIG EFFT

DIG EFFT

↻ OFF ↻ OK

OLD MOVIE

STILL | FLASH | LUMI. | TRAIL

DIG EFFT

↻ OFF ↻ OK

- ||||| LUMI. ||||| +

The bar appears when setting following digital effects modes : STILL, FLASH, LUMI., TRAIL.

### To return to FN

Press EXIT.

### To cancel the digital effect

Press ↻ OFF to return to PAGE1.

## Using special effects – Digital effect

---

### Notes

- The following functions do not work during digital effect:
  - Recording still images on a “Memory Stick” in the tape recording or recording standby
  - Tape photo recording
  - Fader
  - Shutter speed (1/30 or smaller) adjustment
- The following functions do not work in the old movie:
  - Wide mode
  - Picture effect
  - PROGRAM AE
  - Shutter speed adjustment

### When you set the POWER switch to OFF (CHG)

Digital effect is automatically canceled.

# Presetting the adjustment for picture quality – Custom preset

You can preset the camcorder to record the picture with the desired picture quality. When presetting, adjust the picture by shooting a subject and checking the picture displayed on a TV (p. 45).

- (1) Press CUSTOM PRESET to display the CUSTOM PRESET menu while the POWER switch is set to CAMERA or MEMORY/NETWORK (DCR-TRV950 only).
- (2) Press the SEL/PUSH EXEC dial.
- (3) Turn the SEL/PUSH EXEC dial to select SET, then press the dial.
- (4) Turn the SEL/PUSH EXEC dial to select ON, then press the dial.
- (5) Turn the SEL/PUSH EXEC dial to select the desired item, then press the dial.
- (6) Turn the SEL/PUSH EXEC dial to adjust the selected item, then press the dial.
- (7) Press CUSTOM PRESET.

The CUSTOM PRESET menu disappears and the indicator **CP** appears on the screen.

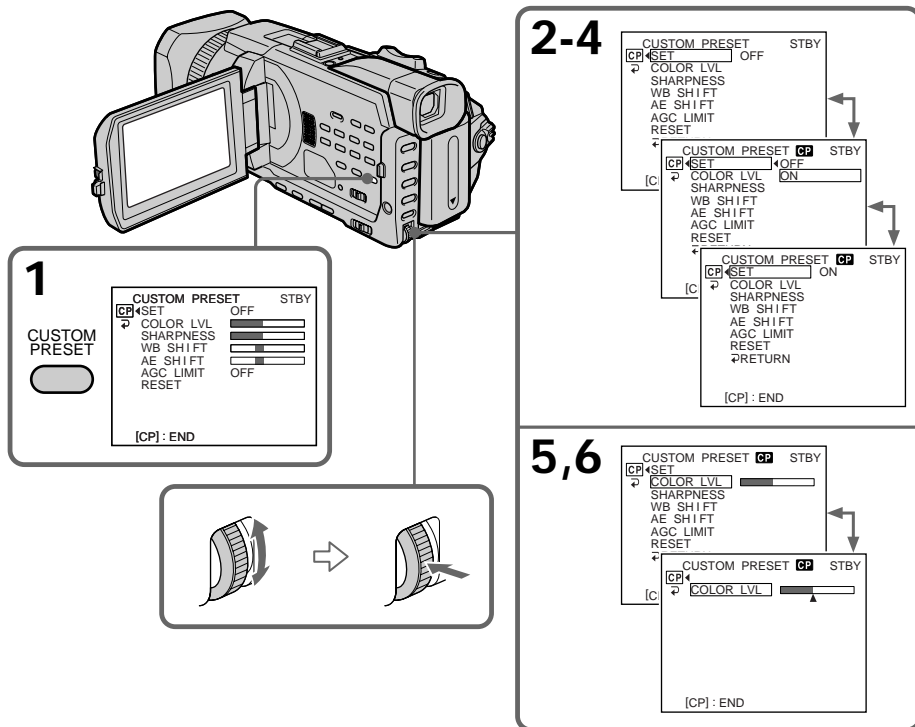

## Presetting the adjustment for picture quality - Custom preset

### Items to be adjusted

Item	Meaning	Adjustment value
COLOR LVL	Color intensity	Decreases color intensity ↔ Increases color intensity
SHARPNESS	Sharpness	Softer ↔ Sharper
WB SHIFT	White balance	Bluish ↔ Reddish
AE SHIFT	Brightness	Dim ↔ Brighten
AGC LIMIT	Auto Gain-limit	6 dB/12 dB/OFF
RESET	Sets items above to the default settings.	

### To cancel using the custom preset

Select OFF in step 4. The setting is still maintained at this moment. To return to the standard setting, select RESET in step 6.

### To check the custom preset setting

Press CUSTOM PRESET while the POWER switch is set to CAMERA or MEMORY / NETWORK (DCR-TRV950 only).

The custom preset setting appears on the screen.

### When you preset the desired picture quality in CAMERA or MEMORY/NETWORK (DCR-TRV950 only)

The preset is only available in each mode you preset. If you want to use a preset both in CAMERA and MEMORY/NETWORK (DCR-TRV950 only), you have to preset in each mode.

### About the AGC Limit

When adjusting the exposure manually, the level of the gain is up to 18 dB (OFF).

# Using the guide frame

You can easily make the picture be on a horizontal line using the guide frame. The guide frame is not recorded in the tape or the "Memory Stick."

- (1) Set GUIDE FRAME in  to ON in the menu setting while the POWER switch is set to CAMERA or MEMORY/NETWORK (DCR-TRV950 only). (p210)
- (2) Press MENU to erase the menu display. The guide frame is displayed on the screen.

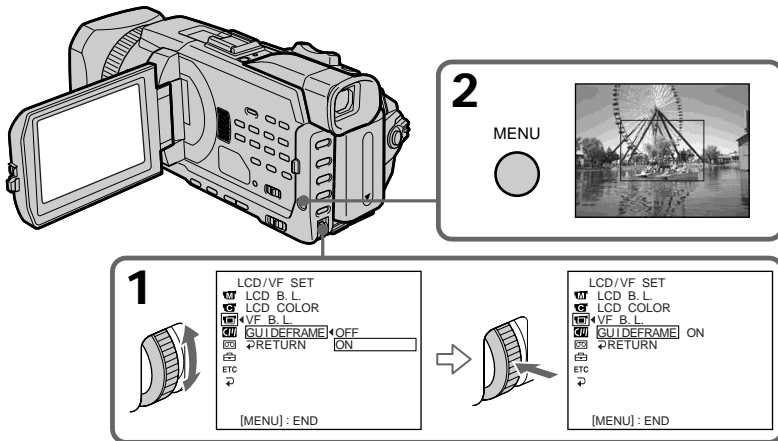

## To clear the guide frame

Select GUIDE FRAME to OFF in the menu setting or simply press DISPLAY/TOUCH PANEL.

### Note

The guide frame indicates only a rough level. The size and position of the guide frame do not affect the setting of the camcorder.

### If you set GUIDEFAME to ON

The other indicators are also displayed on the screen.



# Shooting with the zebra pattern

You can set the camcorder to display a zebra pattern (diagonal stripes) in the portion of the picture on the screen with a subject whose brightness exceeds a certain level. You can check the picture level of a subject by displaying the zebra pattern. Use the zebra pattern as a guide for adjusting the exposure so that you can get the desired picture. The zebra pattern is not recorded in the tape or the "Memory Stick."

Set the ZEBRA selector to 70 or 100 while the POWER switch is set to CAMERA or MEMORY/NETWORK (DCR-TRV950 only).

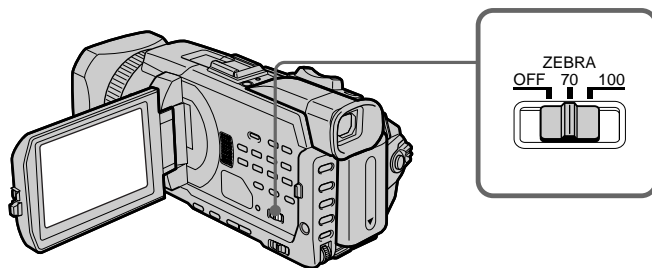

Setting	Meaning
70	The zebra pattern appears in the portion of the picture on the screen with a subject whose brightness is about 70 IRE.
100	The zebra pattern appears in the portion of the picture on the screen with a subject whose brightness exceeds more than 100 IRE.
OFF	The zebra pattern does not appear on the screen.

## To erase the zebra pattern

Set the ZEBRA selector to OFF.

## When the ZEBRA selector is set to 100

The portion of the picture where zebra pattern appears is an area of high brightness and overexposure.

# Using the color bar

---

If you press COLOR BAR, the color bar is displayed on the screen.

Use the color bar in the following cases:

- At the beginning of the recording, the recorded images may be unstable. To avoid this, record the color bar first and start recording the desired images when the captured images become clear.
- To adjust screen color.

Press COLOR BAR while the POWER switch is set to CAMERA.

If you press COLOR BAR again the color bar disappears.

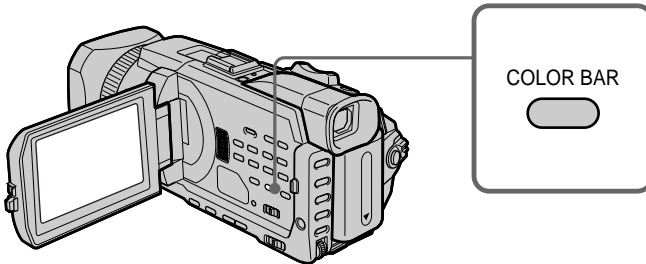

---

## When you adjust color on the screen

Connect your camcorder to the TV (p. 45) and adjust image color on the TV screen.

## While the color bar is displayed

The following functions do not work. However, the settings before the color bar is displayed are retained.

- BACK LIGHT
- SPOT LIGHT
- Picture effect
- Digital effect
- PROGRAM AE
- Shutter speed adjustment
- White balance adjustment
- Exposure
- MEMORY MIX

## While the color bar is displayed during Picture effect, Digital effect or MEMORY MIX

These effects cannot be added on the color bar.

## While using the fader

The color bar cannot be displayed.

# Shooting with manual adjustment

## AUTO LOCK selector

Set the selector as shown below to maintain or release the settings of the functions. Manually adjusted functions are retained even if you set the AUTO LOCK selector to AUTO LOCK. However, all functions will automatically return to the default settings five minutes after removing the power supply.

### AUTO LOCK [a]

Select this position to lock the PROGRAM AE, Shutter speed, White balance, Exposure and Flexible spot meter functions in order to make these function automatically adjusted. We recommend that you set the AUTO LOCK selector to AUTO LOCK if you use the video flash light (optional).

### AUTO LOCK release [b]

Select this position for setting the functions manually.

### HOLD [c]

Select AUTO LOCK release [b], and set the functions manually. Select this position [c] to maintain the settings.

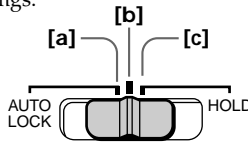

## Using the PROGRAM AE

You can select the PROGRAM AE (Auto Exposure) to suit your specific shooting requirements.

### Soft portrait

This mode brings out the subject while creating a soft background for subjects such as people or flowers.

### Sports lesson

This mode minimizes camera-shake on fast-moving subjects such as in tennis or golf.

### Beach & ski

This mode prevents people's faces from appearing dark in strong light or reflected light, such as at a beach at midsummer or on a ski slope.

### Sunset & moon

This mode allows you to maintain atmosphere when you are recording sunsets, general night views, fireworks displays and neon signs.

### Landscape

This mode is for when you are recording distant subjects such as mountains, and prevents your camcorder from focusing on glass or metal mesh in windows when you are recording a subject behind glass or a screen.



## Shooting with manual adjustment

- (1) Set the AUTO LOCK selector to the center (auto lock release) position while the POWER switch is set to CAMERA or MEMORY/NETWORK(DCR-TRV950 only). (p. 67)
  - (2) Press PROGRAM AE.
  - (3) Turn the SEL/PUSH EXEC dial to select the desired mode, then press the dial.
- The indicator changes as follows:

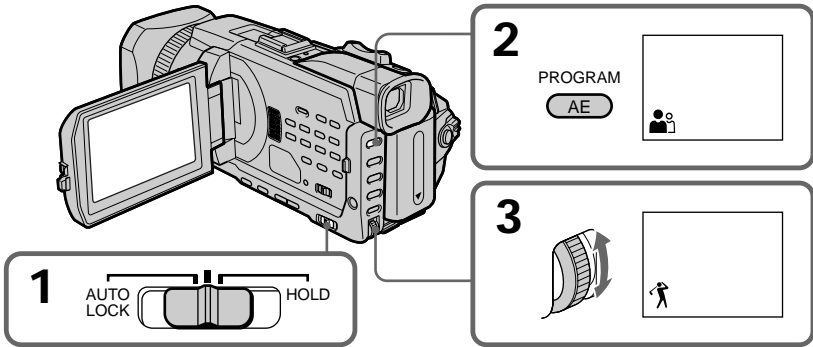

### To cancel the PROGRAM AE

Set the AUTO LOCK selector to the AUTO LOCK or press PROGRAM AE.  
The PROGRAM AE indicator disappears.

## Shooting with manual adjustment

---

### Notes

- Because your camcorder is set to focus only on subjects in the middle to far distance, you cannot take close-ups in the following modes:
  - Sports lesson
  - Beach & ski
- Your camcorder is set to focus only on distant subjects in the following modes:
  - Sunset & moon
  - Landscape
- The following functions do not work in the PROGRAM AE:
  - BOUNCE
  - OLD MOVIE
  - Shutter speed adjustment
  - Spot focus
- When you set the POWER switch to MEMORY/NETWORK (DCR-TRV950 only), Sports lesson does not work. (The indicator flashes.)

### The PROGRAM AE does not work

When you are recording images on a “Memory Stick” using the MEMORY MIX. (The indicator flashes.)

### While WHT BAL is set to automatic adjustment

The white balance is adjusted even if the PROGRAM AE is selected.

### You can adjust the following functions while using the PROGRAM AE

- Backlight
- Spot light
- Exposure
- Flexible Spot Meter

### When recording under a discharge tube such as a fluorescent lamp, sodium lamp or mercury lamp

Flickering phenomenon which lights up or dims the screen, or the color change may occur in the following modes. If this happens, turn the PROGRAM AE off.

- Soft portrait
- Sports lesson

## Shooting with manual adjustment

### Adjusting the shutter speed

You can adjust the shutter speed manually to suit your preference and with its shutter speed fixed.

(1) Set the AUTO LOCK selector to the center (auto lock release) position while the POWER switch is set to CAMERA or MEMORY/NETWORK(DCR-TRV950 only). (p. 67)

(2) Press SHUTTER SPEED. The shutter speed indicator appears on the screen.

(3) Turn the SEL/PUSH EXEC dial to select the desired speed. The available shutter speed ranges from 1/4 to 1/10000. As you turn the dial, the shutter speed changes as follows:

[CAMERA] 1/4 ↔ 1/8 ↔ 1/15 ↔ 1/30 ↔ ... ↔ 1/4000 ↔ 1/6000  
↔ 1/10000

[MEMORY/NETWORK] 1/60 ↔ 1/90 ↔ 1/100 ↔ 1/125 ↔ 1/180  
↔ 1/250 ↔ 1/350 ↔ 1/500

The shutter speed increases when a smaller number is selected. The size of the picture displayed on the screen also increases. Conversely, the shutter speed is slower when a larger number is selected. The picture displayed on the screen will thus decrease in size.

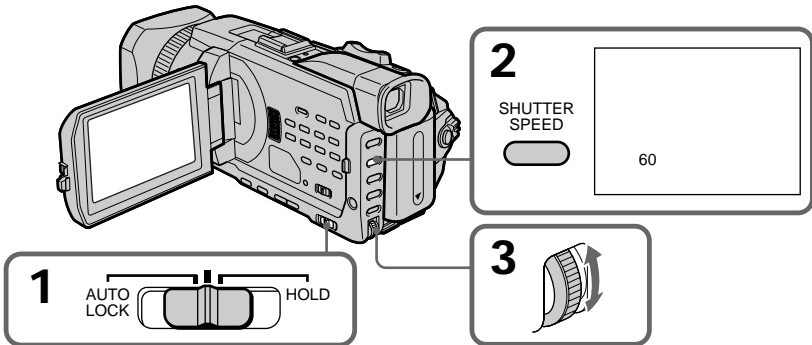

### To return to automatic shutter speed mode

Set the AUTO LOCK selector to AUTO LOCK or press SHUTTER SPEED. The shutter speed indicator disappears.

#### Notes

- If you set the shutter speed value to 1/30 or smaller, You cannot use the flash and the digital effect.
- The Shutter speed cannot be adjusted while you are using the following functions.
  - PROGRAM AE
  - Exposure
  - Flexible spot meter

#### If you press PROGRAM AE

Shutter speed adjusted manually returns to the automatic shutter speed.

## Shooting with manual adjustment

---

### **When the shutter speed is fast**

When shooting a bright subject, vertical lines may appear on the image, but this is not a malfunction. In such cases, set the shutter speed a little slower.

### **When shooting at slow shutter speed**

At slow shutter speed, automatic focus may be lost. Use a tripod and adjust the focus manually.

### **When recording under a discharge tube such as a fluorescent lamp, sodium lamp or mercury lamp**

Flickering phenomenon which lights up or dims the screen, or the color change may occur depending on the shutter speed.

### **When the POWER switch is set to MEMORY/NETWORK (DCR-TRV950 only)**

Shutter speeds available in the MEMORY/NETWORK(DCR-TRV950 only) mode are different from those in the CAMERA mode.

Even if you set the shutter speed faster than 1/500 or slower than 1/60 while the POWER switch is set to CAMERA, the shutter speed setting is automatically reset to 1/500 or 1/60 respectively if you set the POWER switch to MEMORY/NETWORK(DCR-TRV950 only).

# Shooting with manual adjustment

## Adjusting the white balance

White balance adjustment makes white subjects look white and allows more natural color balance for camera recording. You can obtain better results by adjusting the white balance manually when lighting conditions change quickly or when recording outdoors: e.g., neon signs, fireworks.

- (1) Set the AUTO LOCK selector to the center (auto lock release) position while the POWER switch is set to CAMERA or MEMORY/NETWORK (DCR-TRV950 only). (p. 67)
- (2) Press WHT BAL.
- (3) Turn the SEL/PUSH EXEC dial to select the appropriate white balance mode under the following conditions. As you turn the dial, the display changes as follows:  
☑ (One-push white balance) ↔ ☀ (Outdoor) ↔ ☹ (Indoor)

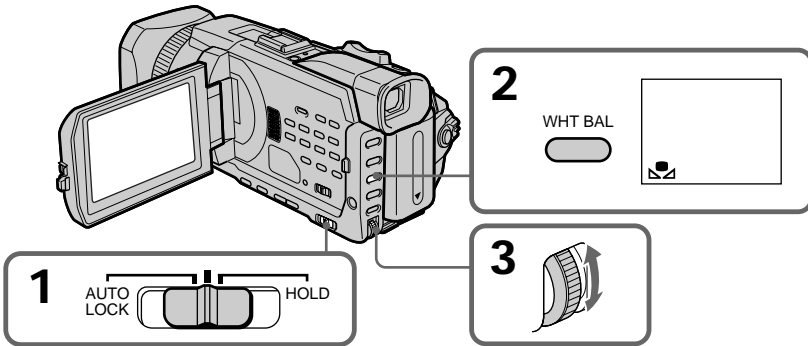

Indicator	Shooting conditions
☑ (One-push white balance)	<ul style="list-style-type: none"><li>• Adjusting the white balance according to the light source. Follow the procedure described on the next page to adjust the setting again.</li></ul>
☀ (Outdoor)	<ul style="list-style-type: none"><li>• Recording a sunset/sunrise, just after sunset, just before sunrise, neon signs, or fireworks</li><li>• Under a color matching fluorescent lamp</li></ul>
☹ (Indoor)	<ul style="list-style-type: none"><li>• Lighting condition changes quickly</li><li>• Too bright a place such as a photography studio</li><li>• Under sodium lamps or mercury lamps</li></ul>



## Shooting with manual adjustment

---

### If you have selected in step 3

When you set the white balance to one-push white balance mode, the setting is locked and maintained even if lighting conditions change. You can achieve recording with natural colors without the image being affected by ambient light.

(1) Shoot a white object such as paper fully with  displayed on the screen in the recording standby.

(2) Press the SEL/PUSH EXEC dial.

The  indicator flashes quickly. When the white balance has been adjusted and stored in the memory, the indicator stops flashing. The setting will be maintained even after removing the power supply.

### To return to automatic adjustment



Set the AUTO LOCK selector to AUTO LOCK or press WHT BAL. The white balance indicator disappears.

---

### If the picture is being taken in a studio lit by TV lighting

We recommend that you record in the  (indoor) mode.

### When you record under fluorescent lamp

Use the automatic white balance mode or the  (one-push white balance) mode. Your camcorder may not adjust the white balance correctly if you use the  (indoor) mode.

### Shooting when lighting conditions have changed

Readjust the white balance while the camcorder is in standby mode. White balance cannot be adjusted in the  (One-push white balance) mode during recording.

### If the indicator does not stop flashing after you press the SEL/PUSH EXEC dial

The white balance cannot be set. Use the automatic mode for recording.

### In automatic white balance mode

Point your camcorder at a white subject for about 10 seconds after setting the POWER switch to CAMERA to get a better adjustment when:

- You detach the battery for replacement.
- You bring your camcorder outdoors from the interior of a house, or vice versa.

## Shooting with manual adjustment

### Adjusting the exposure

You can manually adjust and set the exposure. Adjust the exposure manually in the following cases:

- When you need a fine adjustment for the backlit subjects.
- When shooting subjects and dark backgrounds.
- When recording dark pictures (e.g. night scenes) faithfully.

- (1) Set the AUTO LOCK selector to the center (auto lock release) position while the POWER switch is set to CAMERA or MEMORY/NETWORK(DCR-TRV950 only). (p. 67)
- (2) Press EXPOSURE. The exposure indicator appears.
- (3) Turn the SEL/PUSH EXEC dial to adjust the brightness.

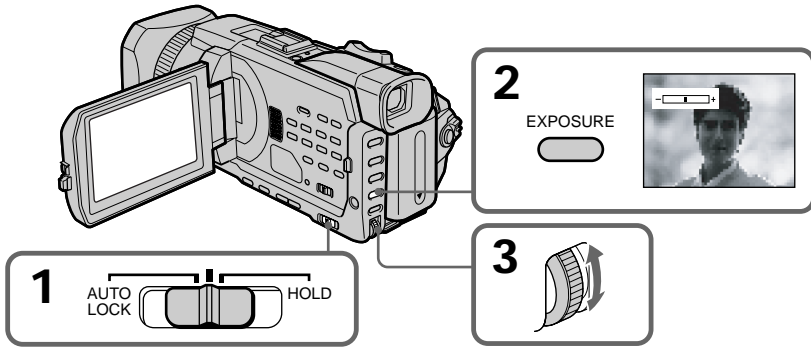

### To return to automatic exposure

Set the AUTO LOCK selector to AUTO LOCK or press EXPOSURE. The exposure indicator disappears.

**When you adjust the exposure manually, the following functions do not work:**

- Backlight
- Spot light
- Shutter speed adjustment

### If you press PROGRAM AE

Your camcorder also returns to automatic exposure.

## Shooting with manual adjustment

### Using the spot light-metering – Flexible Spot Meter

You can take a picture with the appropriate exposure automatically for just the point you want to focus on and with its exposure fixed. Use the Flexible Spot Meter in the following cases:

- When adjusting the exposure manually to shoot the backlit subjects.
- When there is strong contrast between the subject and background such as with a subject that is on stage and lighted by a spotlight.

- (1) Set the AUTO LOCK selector to the center (auto lock release) position while the POWER switch is set to CAMERA or MEMORY / NETWORK (DCR-TRV950 only). (p. 67)
- (2) Press FN to display PAGE1.
- (3) Press SPOT METER. The SPOT METER screen appears.
- (4) Press the desired area in the frame on the LCD screen.  
The SPOT METER indicator flashes on the LCD screen. The exposure of the point you selected is adjusted.
- (5) Press  $\Rightarrow$  OK to return to PAGE1.

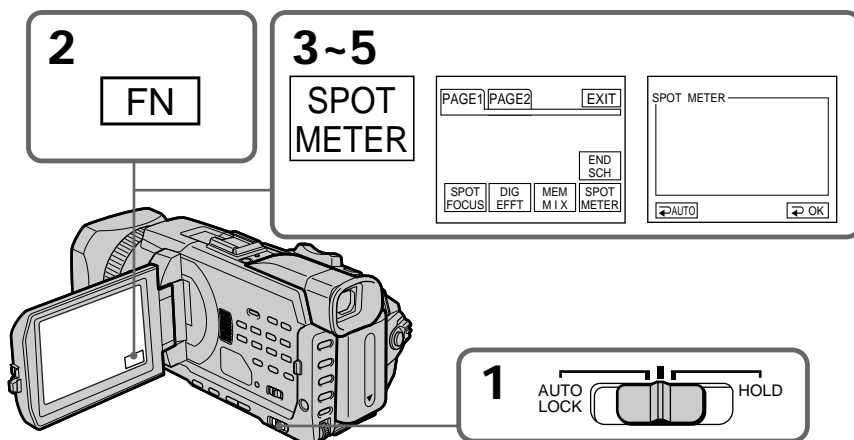

#### To return to FN

Press EXIT.

#### To return to automatic exposure

Set the AUTO LOCK selector to AUTO LOCK or press  $\Rightarrow$  AUTO to return to PAGE1.

#### The following functions do not work during Flexible Spot Meter

- Backlight
- Spot light
- Shutter speed adjustment

#### If you press PROGRAM AE

Your camcorder also returns to automatic exposure.

# Focusing manually

You can gain better results by manually adjusting the focus in the following cases. Normally, focus is automatically adjusted.

- The autofocus is not effective when shooting:
  - Subjects through glass coated with water droplets
  - Horizontal stripes
  - Subjects with little contrast with backgrounds such as walls and sky
- When you want to change the focus from a subject in the foreground to a subject in the background.
- Shooting a stationary subject when using a tripod.

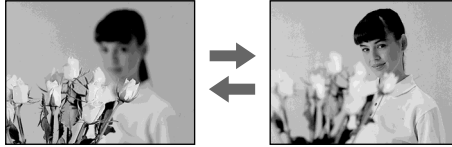

- (1) Set FOCUS to MAN while the POWER switch is set to CAMERA or MEMORY/NETWORK (DCR-TRV950 only).  
The  indicator appears.
- (2) Turn the focus ring to sharpen focus.

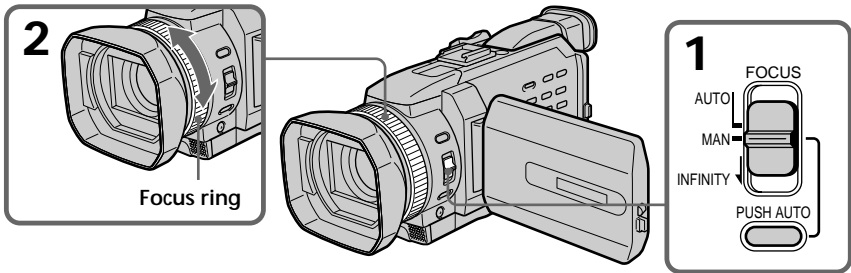

## To return to the autofocus

Set FOCUS to AUTO.

## To record distant subjects

When you set FOCUS to INFINITY, the focus changes to a setting appropriate for an object in the far distance, and the  indicator appears. When you release FOCUS, your camcorder returns to the manual focus. Use this mode when your camcorder focuses on near objects even though you are trying to shoot a distant object.

## To shoot with auto focusing momentarily

Press PUSH AUTO.

The auto focus functions while you are pressing PUSH AUTO.

Use this button to focus on one subject and then another with smooth focusing. When you release PUSH AUTO, manual focusing resumes.

## Focusing manually

---



### To focus precisely

It is easier to focus on subjects if you adjust the zoom to shoot at the “W” (wide-angle) after focusing at the “T” (telephoto) position.

### When you shoot close to the subject

Focus at the end of the “W” (wide-angle) position.

### changes as follows:

-  when recording a distant subject
-  when the subject is too close to focus on

### Focal distance information is displayed for about three seconds on the screen in the following cases:

- When switching the focus adjustment mode from autofocus to manual
- When turning the focus ring

### Focal distance information

- This information aids focusing if it is not easy to focus on the subject, for example, when recording in the dark. Use this information as a rough guide to get a sharp focus.
- You cannot get correct information if you have attached a conversion lens (optional) to your camcorder.

# Using the spot focus – Spot Focus

You can take a picture with the appropriate focus automatically for just the point you want to focus on and with its focus fixed.

- (1) Set FOCUS to MAN while the POWER switch is set to CAMERA or MEMORY / NETWORK (DCR-TRV950 only).
- (2) Press FN to display PAGE1.
- (3) Press SPOT FOCUS. The SPOT FOCUS screen appears.
- (4) Press the desired area in the frame on the LCD screen.  
The SPOT FOCUS indicator flashes on the LCD screen. The spot focus of the point you selected is adjusted.
- (5) Press  OK to return to PAGE1.

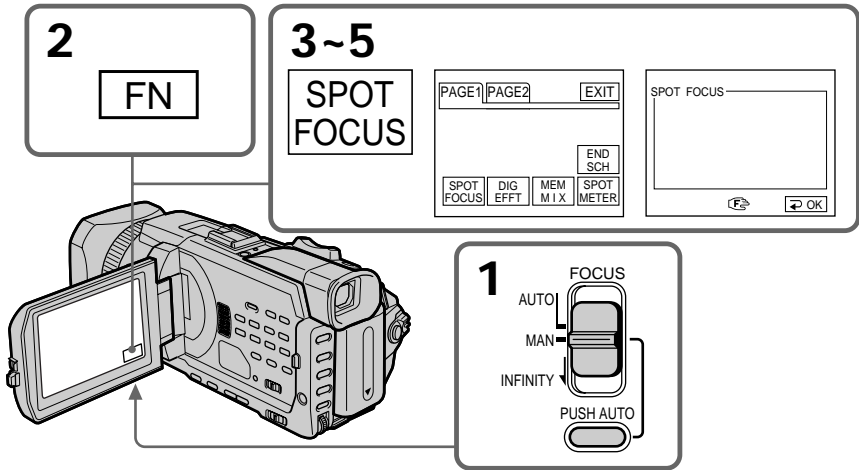

## To return to FN

Press EXIT.

## To return to the autofocus

Set FOCUS to AUTO.

---

## When Using PROGRAM AE

Spot focus do not work.

## Focal distance information

It is not displayed on the screen.

# Adjusting recording level manually – Sound recording level

You can adjust the recording sound level. Use headphones to monitor the sound when you adjust it.

- (1) Set MIC LEVEL in  to MANUAL in the menu setting while the POWER switch is set to CAMERA or VCR. (p. 214)
- (2) Press MENU to erase the menu display.
- (3) Press AUDIO LEVEL to display the recording level adjustment display in standby mode.
- (4) Turn the SEL/PUSH EXEC dial to adjust the recording level.

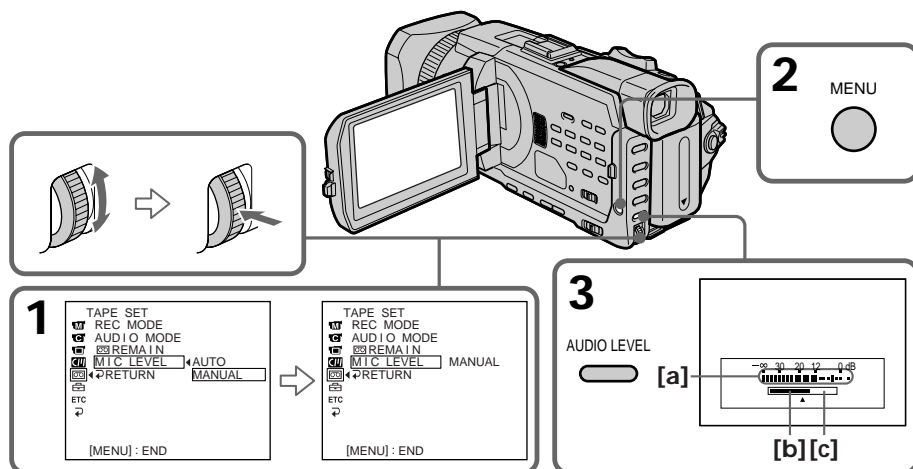

- [a] Recording level meter
- [b] Decreases the recording level
- [c] Increases the recording level

## To clear the recording level adjustment display

Press AUDIO LEVEL.

## To return to automatic recording sound level

Set MIC LEVEL to AUTO in the menu setting.

## **Adjusting recording level manually – Sound recording level**

---

### **Notes on the manual adjustment**

- The recording level setting is retained for about five minutes even after removing the power supply.
- The recording level indicator appears at the lower-right on the screen.

### **The sound input through the AUDIO/VIDEO jack or the DV Interface**

You cannot adjust the recording level.

### **When MIC LEVEL is set to AUTO**

You cannot adjust the recording level, however, the recording level adjustment display is displayed.



# Interval recording

You can make a time-lapse recording by setting the camcorder to automatically record and standby sequentially. You can achieve an excellent recording for flowering, gradual appearances, etc., with this function.

## Example

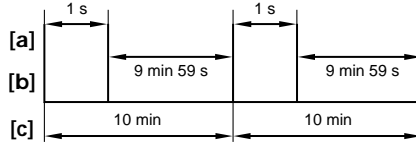

- [a] REC TIME  
[b] Waiting time  
[c] INTERVAL

- (1) In the standby, set INT. REC in to SET in the menu setting. (p. 209)
- (2) Turn the SEL/PUSH EXEC dial to set INTERVAL and REC TIME.
  - ① Turn the SEL/PUSH EXEC dial to select INTERVAL, then press the dial.
  - ② Turn the SEL/PUSH EXEC dial to select the desired interval time, then press the dial.  
The time: 30SEC ↔ 1MIN ↔ 5MIN ↔ 10MIN
  - ③ Turn the SEL/PUSH EXEC dial to select REC TIME, then press the dial.
  - ④ Turn the SEL/PUSH EXEC dial to select the desired recording time, then press the dial.  
The time: 0.5SEC ↔ 1SEC ↔ 1.5SEC ↔ 2SEC
  - ⑤ Turn the SEL/PUSH EXEC dial to select RETURN, then press the dial.
- (3) Turn the SEL/PUSH EXEC dial to select ON, then press the dial.

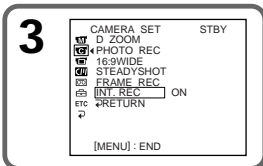
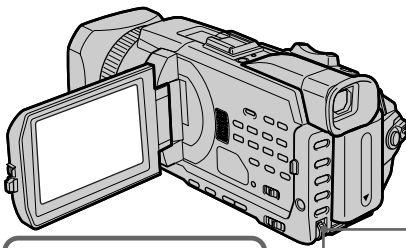

<b>1</b>	CAMERA SET STBY D ZOOM PHOTO REC 16:9/WIDE STEADYSHOT FRAME REC INT. REC  ON OFF SET ETC RETURN [MENU]: END	CAMERA SET STBY INT. REC INTERVAL 30SEC REC TIME RETURN ETC RETURN [MENU]: END	
	<b>2</b>	CAMERA SET STBY INT. REC INTERVAL 30SEC REC TIME RETURN ETC RETURN [MENU]: END	CAMERA SET STBY INT. REC INTERVAL 10SEC REC TIME 1MIN 5MIN 10MIN RETURN ETC RETURN [MENU]: END
<b>3</b>	CAMERA SET STBY D ZOOM PHOTO REC 16:9/WIDE STEADYSHOT FRAME REC INT. REC ON ETC RETURN [MENU]: END	CAMERA SET STBY INT. REC INTERVAL 0.5SEC REC TIME RETURN ETC RETURN [MENU]: END	CAMERA SET STBY INT. REC INTERVAL 1.5SEC REC TIME 0.5SEC 1.5SEC 2SEC RETURN ETC RETURN [MENU]: END

(continued on the following page)

## Interval recording

---

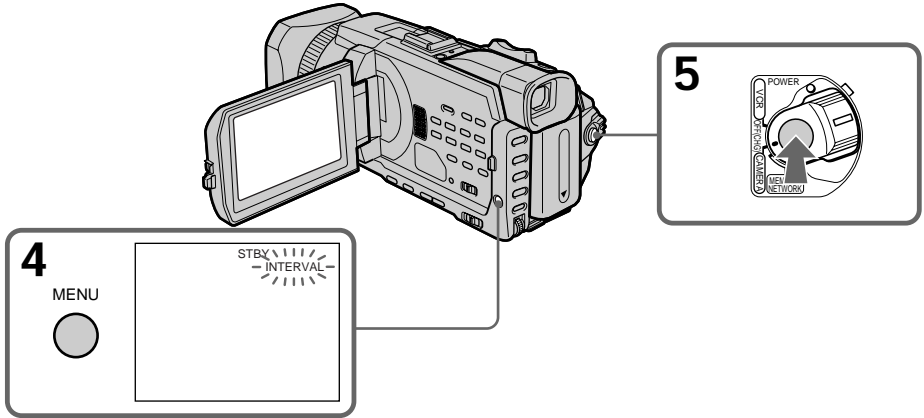

(4) Press MENU to erase the menu display. The INTERVAL indicator flashes.

(5) Press START/STOP to start interval recording. The INTERVAL indicator lights up.

### To cancel the interval recording

Perform either of the following:

- Set INT. REC to OFF in the menu settings.
- Set the POWER switch to other than CAMERA.

### To perform normal recording during the interval recording

Press START/STOP.

The INTERVAL indicator flashes. During the waiting time you can perform normal recording only once.

To stop normal recording, press START/STOP again. Step 4 is displayed on the screen.

---

### On recording time

There may be a discrepancy in the recording time of up to +/- six frames from the selected time.

### When pressing START/STOP during recording time

Interval recording stops. To restart it, press START/STOP again.

# Frame by frame recording

## - Frame recording

You can make a recording with a stop-motion animated effect using frame recording. To create this effect, alternately move the subject a little and make a frame recording. We recommend that you use a tripod, and operate your camcorder using the Remote Commander after step 3.

- (1) In the standby, set FRAME REC in  to ON in the menu setting. (p.209)
- (2) Press MENU to erase the menu display.  
The FRAME REC indicator lights up.
- (3) Press START/STOP to start frame recording. Your camcorder makes a recording for about six frames, and returns to recording standby.
- (4) Move the subject, and repeat step 3.

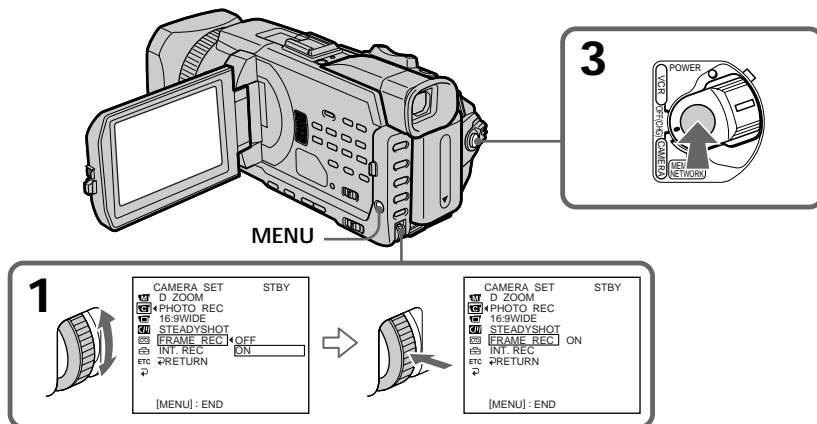

### To cancel the frame recording

Perform either of the following:

- Set FRAME REC to OFF in the menu settings.
- Set the POWER switch to other than CAMERA.

### Note

The remaining tape time is not indicated correctly if you use this function continuously.

### When using the frame recording

The last recorded frame is longer than other frames.

# Playing back tapes with picture effect

During playback, you can process a scene using the following picture effect: NEG. ART, SEPIA, B&W and SOLARIZE.

- (1) In the playback or playback pause, press MENU, then select P EFFECT in  with the SEL/PUSH EXEC dial, then press the dial (p. 208).
- (2) Turn the SEL/PUSH EXEC dial to select the desired mode, then press the dial.  
For details of each picture effect, see page 58.

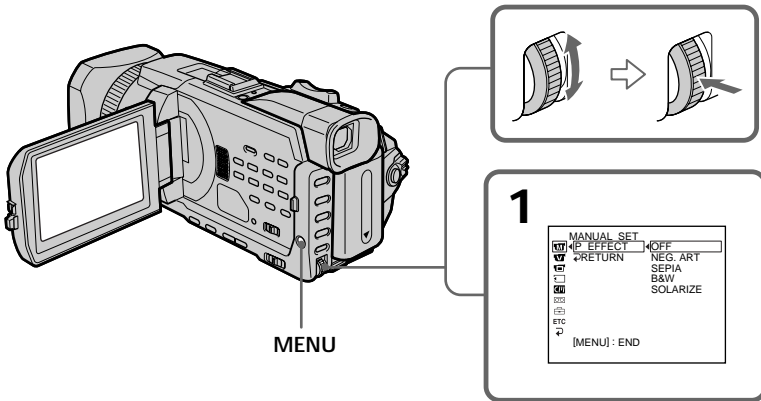

## To cancel the picture effect

Set P EFFECT to OFF in the menu settings.

### Notes

- You cannot process externally input scenes using picture effect.
- You cannot record images on a tape on your camcorder when you have processed the image using the picture effect. However, you can record images on a “Memory Stick” (p. 144, 156), or on a VCR using your camcorder as a player.

### Pictures processed by picture effect

Pictures processed by picture effect are not output through the  iDV Interface.

### When you set the POWER switch to OFF (CHG) or stop playing back

Picture effect is automatically canceled.

# Playing back tapes with digital effect

During playback, you can process a scene using the following digital effect: STILL, FLASH, LUMI. and TRAIL.

- (1) In the playback or playback pause, press FN and select PAGE2.
- (2) Press DIG EFFT. The screen to select a desired digital effect appears.
- (3) Press a desired mode. In the STILL or LUMI., the picture where you select the mode is stored in memory as a still image.
- (4) Press -/+ to adjust the effect. Refer to page 60 for details.
- (5) Press  $\rightarrow$  OK to return to PAGE2.

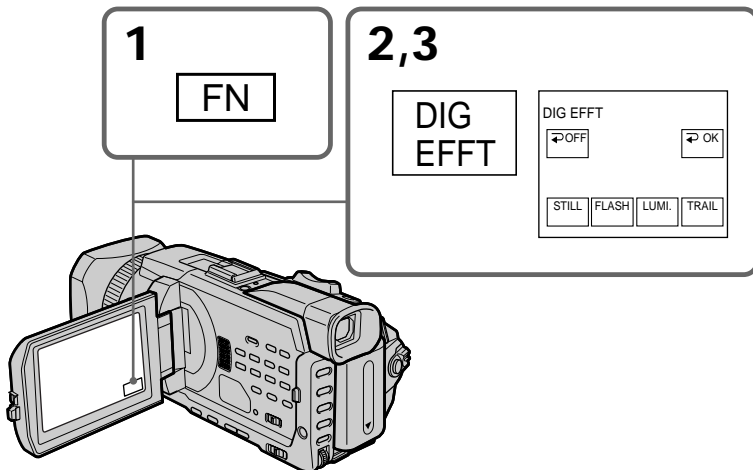

## To return to FN

Press EXIT.

## To cancel the digital effect

Press  $\rightarrow$  OFF to return to PAGE2.

### Notes

- You cannot process externally input scenes using digital effect.
- You cannot record images on a tape on your camcorder when you have processed the image using digital effect. However, you can record images on a "Memory Stick" (p. 144, 156), or on a VCR using your camcorder as a player.

### Pictures processed by digital effect

Pictures processed by digital effect are not output through the  $\square$  DV Interface.

### When you set the POWER switch to OFF (CHG) or stop playing back

Digital effect is automatically canceled.

# Enlarging images recorded on tapes

## - Tape PB ZOOM

You can enlarge playback images recorded on tapes. Besides the operation described here, your camcorder can enlarge still images recorded on the "Memory Stick" (p. 173).

- (1) In the playback or playback pause, press FN and select PAGE2.
- (2) Press PB ZOOM. The PB ZOOM screen appears.
- (3) Press the area you want to enlarge in the frame on the PB ZOOM screen.  
The area you pressed moves to the center of the screen, and the playback image is enlarged approximately at twice the size. If you press the other area again, the area moves to the center of the screen.
- (4) Adjust the zoom ratio by the power zoom lever.  
You can enlarge the image from approximately 1.1 times up to five times its size.  
W: Decreases the zoom ratio.  
T: Increases the zoom ratio.

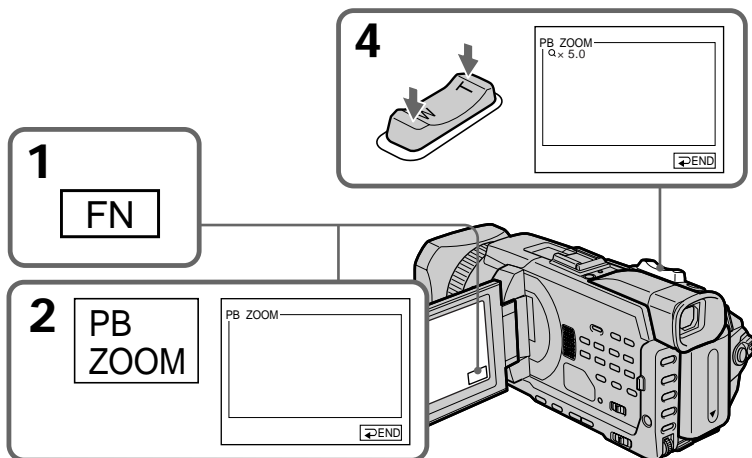

### To cancel the PB ZOOM

Press  END.

## Enlarging images recorded on tapes – Tape PB ZOOM

---



### Notes

- You cannot process externally input scenes using the PB ZOOM.
- You cannot record images on a tape on your camcorder when you have processed the image using the tape PB ZOOM. However, you can record images on a VCR using your camcorder as a player.
- You cannot record moving pictures on a “Memory Stick” on your camcorder when you have processed the picture using the tape PB ZOOM.

### The PB ZOOM is automatically canceled when you activate the following:

- Set the POWER switch to OFF (CHG).
- Stop playback.
- Press MENU.
- Insert a “Memory Stick”.

### Pictures in the PB ZOOM

Pictures in the PB ZOOM are not output through the  DV Interface and the  (USB) jack.

### In the PB ZOOM

If you press DISPLAY/TOUCH PANEL button, the frame on the PB ZOOM screen disappears. You cannot move the part you pressed to the center of the screen.

### Edge of the enlarged image

The edge of the enlarged image cannot be displayed at the center of the screen.

# Quickly locating a scene

## - ZERO SET MEMORY

---

Your camcorder goes forward or backward to automatically stop at a desired scene having a tape counter value of "0:00:00". Use the Remote Commander for this operation.

- (1) In the playback, press DISPLAY when the tape counter does not appear.
- (2) Press ZERO SET MEMORY at the point you want to locate later. The tape counter shows "0:00:00" and then starts counting. The ZERO SET MEMORY indicator flashes.
- (3) Press ■ when you want to stop playback.
- (4) Press ◀ to rewind the tape to the tape counter's zero point. The tape stops automatically when the tape counter reaches approximately zero. The ZERO SET MEMORY indicator disappears, and the time code appears.
- (5) Press ▶. Playback starts from the counter's zero point.

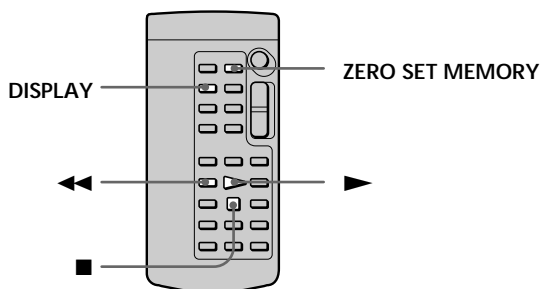

---

### Notes

- When you press ZERO SET MEMORY before rewinding the tape, the zero set memory will be canceled.
- There may be a discrepancy of several seconds from the time code.
- The ZERO SET MEMORY indicator disappears when you press FN.

### If a tape has a blank portion between recorded portions

The zero set memory may not work correctly.



# Searching the boundaries of a recorded tape by title – TITLE SEARCH



**CM only** If you use a cassette with cassette memory, you can search for the boundaries of a recorded tape by title. Use the Remote Commander for this operation.

## Before operation

Set CM SEARCH in  to ON in the menu settings. (The default setting is ON.)

- (1) Set the POWER switch to VCR.
- (2) Press SEARCH MODE on the Remote Commander repeatedly until the TITLE SEARCH indicator appears. The indicator changes as follows:



- (3) Press  or  on the Remote Commander to select the title for playback. Your camcorder automatically starts playback of the scene having the title that you selected.

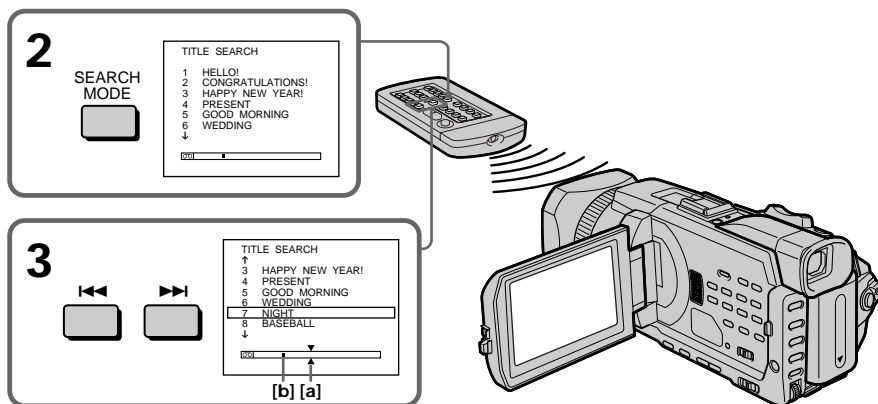

[a] Actual point you are trying to search for

[b] Present point on the tape

## To stop searching

Press .

## If you use a cassette without cassette memory

You cannot superimpose or search a title.

## If a tape has a blank portion between recorded portions

The title search may not work correctly.

## To superimpose a title

See page 119.

# Searching a recording by date

## - DATE SEARCH

You can automatically search for the point where the recording date changes and start playback from that point (**date search**). Use a cassette with cassette memory for convenience. Use the Remote Commander for this operation. Use this function to check where recording dates change or to edit the tape at each recording date.



### Searching for the date by using cassette memory

#### Before operation

- You can use this function only when playing back a cassette with cassette memory.
- Set CM SEARCH in  to ON in the menu settings. (The default setting is ON.)

- (1) Set the POWER switch to VCR.
- (2) Press SEARCH MODE on the Remote Commander repeatedly until the DATE SEARCH indicator appears. The indicator changes as follows:



- (3) Press  or  on the Remote Commander to select the date for playback. Your camcorder automatically starts playback at the beginning of the selected date.

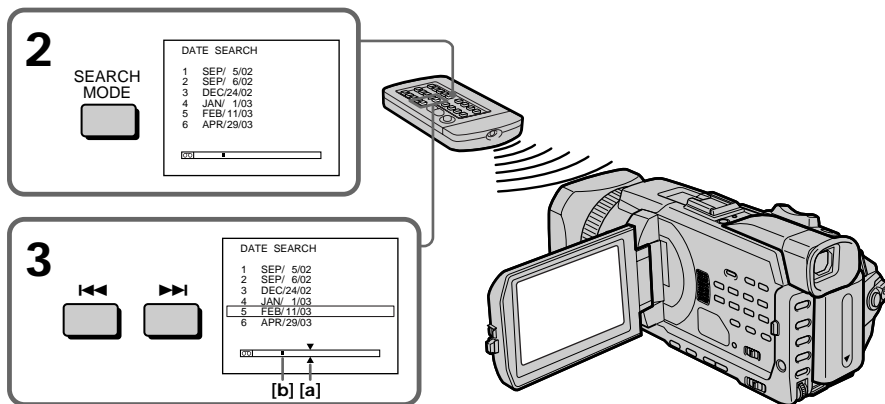

[a] Actual point you are trying to search for  
[b] Present point on the tape

#### To stop searching

Press .

## Searching a recording by date – DATE SEARCH

### Note

If one day's recording is less than two minutes, your camcorder may not accurately find the point where the recording date changes.

### If a tape has a blank portion between recorded portions

DATE SEARCH may not work correctly.





### Cassette memory

The tape with cassette memory can hold six recording dates. If you search among seven or more dates, see "Searching for the date without using cassette memory" below.

## Searching for the date without using cassette memory

- (1) Set the POWER switch to VCR.
- (2) Press MENU, then select CM SEARCH in  to OFF with the SEL/PUSH EXEC dial (p. 213).
- (3) Press SEARCH MODE on the Remote Commander repeatedly until the DATE SEARCH indicator appears. The indicator changes as follows:

→DATE SEARCH → PHOTO SEARCH → PHOTO SCAN → (no indicator)→

- (4) Press  on the Remote Commander to search for the previous date or press  on the Remote Commander to search for the next date. Your camcorder automatically starts playback at the point where the date changes. Each time you press  or  your camcorder searches for the previous or next date.

### To stop searching

Press .







## Searching for a photo – PHOTO SEARCH/PHOTO SCAN

### Searching for a photo without using cassette memory

- (1) Set the POWER switch to VCR.
- (2) Press MENU, then turn the SEL/PUSH EXEC dial to select CM SEARCH in  to OFF, then press the dial (p. 213).
- (3) Press SEARCH MODE on the Remote Commander repeatedly until the PHOTO SEARCH indicator appears. The indicator changes as follows:

→ DATE SEARCH → PHOTO SEARCH → PHOTO SCAN → (no indicator) →

- (4) Press  or  on the Remote Commander to select the photo for playback. Each time you press  or  your camcorder searches for the previous or next photo.  
Your camcorder automatically starts playback of the photo.

#### To stop searching

Press .

## Searching for a photo – PHOTO SEARCH/PHOTO SCAN

### Scanning photos

- (1) Set the POWER switch to VCR.
- (2) Press SEARCH MODE on the Remote Commander repeatedly until the PHOTO SCAN indicator appears. The indicator changes as follows:



\* Displayed only when CM SEARCH is set to ON in the menu settings.

- (3) Press ◀◀ or ▶▶ on the Remote Commander.  
Each photo is played back for about five seconds automatically.

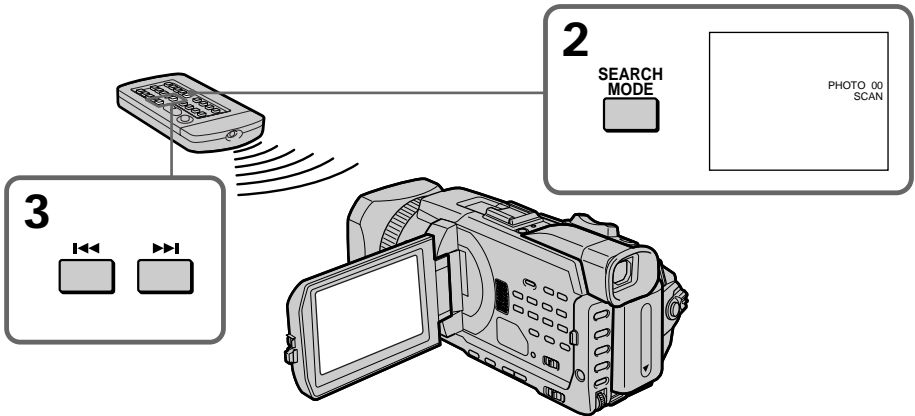

### To stop scanning

Press ■.

---

**If a tape has a blank portion between recorded portions**  
PHOTO SEARCH/PHOTO SCAN may not work correctly.

**The available number of photos that can be searched using the cassette memory**  
The available number is up to 12 photos. However, you can search 13 photos or more using the PHOTO SCAN.

# Dubbing a tape

## Using the A/V connecting cable

You can dub or edit on the VCR connected to your camcorder using your camcorder as a player.

Connect your camcorder to the VCR using the A/V connecting cable supplied with your camcorder.

### Before operation

- Set DISPLAY in **[ETC]** to LCD in the menu settings. (The default setting is LCD.)
- Press the following buttons to make the indicator disappear so that they will not be superimposed on the edited tape:

On your camcorder:

DISPLAY/TOUCH PANEL, DATA CODE

On the Remote Commander:

DISPLAY, DATA CODE, SEARCH MODE

- (1) Insert a blank tape (or a tape you want to record over) into the VCR, and insert the recorded tape into your camcorder.
- (2) Prepare the VCR for recording, then set the input selector to LINE. Connect the A/V connecting cable to the AUDIO/VIDEO jack. Refer to the operating instructions of the VCR.
- (3) Set the POWER switch to VCR on your camcorder.
- (4) Play back the recorded tape on your camcorder.
- (5) Start recording on the VCR. Refer to the operating instructions of your VCR.

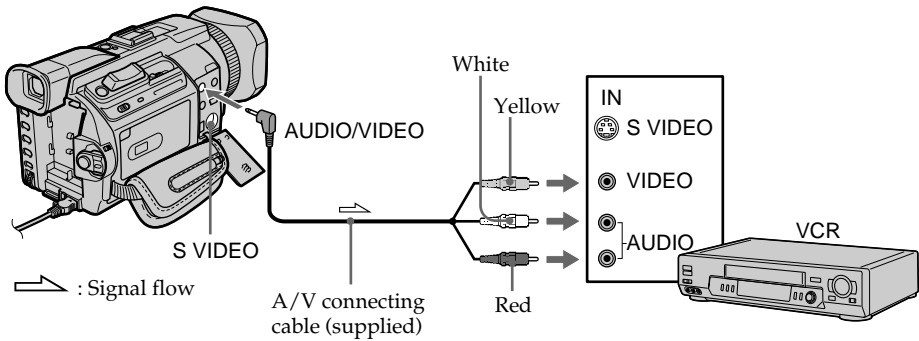





## When you have finished dubbing a tape







Press **■** on both your camcorder and the VCR.

## Dubbing a tape

---

You can edit on VCRs that support the following systems:

 8 mm,  Hi8,  VHS,  S-VHS,  VHS-C,  S-VHS-C,

 Betamax,  ED Beta,  mini DV,  DV,  Digital8,  MICRO MV

### If your VCR is a monaural type

Connect the yellow plug of the A/V connecting cable to the video input jack and the white or the red plug to the audio input jack on the VCR or the TV. When the white plug is connected, the left channel audio is output, and when the red plug is connected, the right channel audio is output.

### If your VCR has an S video jack

Pictures can be reproduced more faithfully by using an S video cable (optional).

With this connection, you do not need to connect the yellow (video) plug of the A/V connecting cable.

Connect an S video cable (optional) to the S video jacks of both your camcorder and the VCR.

This connection produces higher quality DV format pictures.



## Dubbing a tape

### Using the i.LINK cable

Simply connect the i.LINK cable (optional) to the **i** DV Interface on your camcorder and to DV IN on the DV products. With a digital-to-digital connection, video and audio signals are transmitted in digital form for high-quality editing. You cannot dub the titles, display indicators or the contents of cassette memory or letters on the "Memory Stick" index screen.

Set the input selector on the VCR to the DV input position if the VCR is equipped with the input selector.

- (1) Insert a blank tape (or a tape you want to record over) into the VCR, and insert the recorded tape into your camcorder.
- (2) Prepare the VCR for recording, then set the input selector to LINE. Refer to the operating instructions of the VCR.
- (3) Set the POWER switch to VCR on your camcorder.
- (4) Play back the recorded tape on your camcorder.
- (5) Start recording on the VCR. Refer to the operating instructions of the VCR.

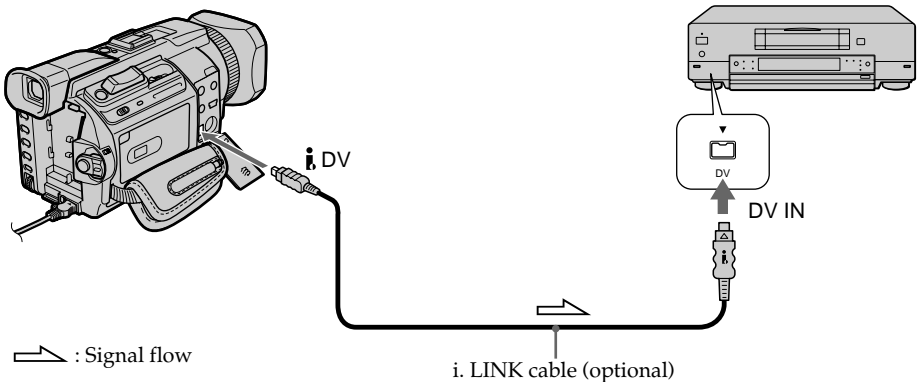

### When you have finished dubbing a tape

Press **■** on both your camcorder and the VCR.

---

You can connect one VCR only using the i.LINK cable

See page 233 for more information about i.LINK.

**Pictures processed by the picture effect, the digital effect or PB ZOOM**

These pictures are not output through the **i** DV Interface.

**If you record a playback pause picture with the **i** DV Interface**

The recorded picture becomes rough. Also, when you play back the picture using other video equipment, the picture may jitter.

# Dubbing only desired scenes

## - Digital program editing (on tapes)

You can duplicate selected scenes (programs) for editing onto a tape without operating the VCR.

Scenes can be selected by frame. You can set up to 20 programs.

Your camcorder can dub on a "Memory Stick." See p. 160 for more information.

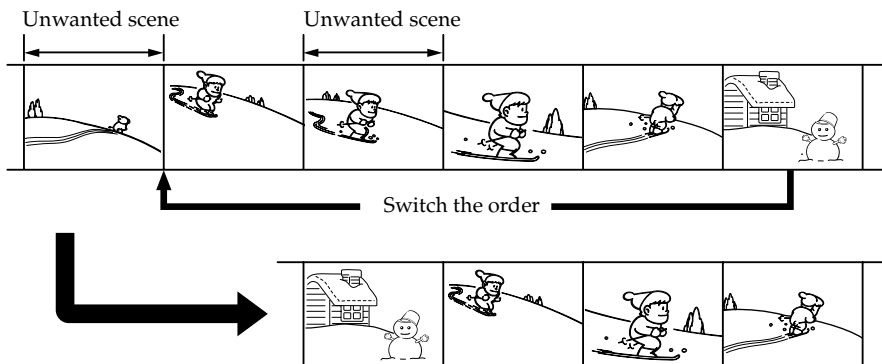

### Before operating the Digital program editing on tapes recorded on other equipment

**Step 1** Connecting the VCR.

**Step 2** Setting the VCR for operation (p. 99, 103).

**Step 3** Adjusting the synchronization of the VCR (p. 104).

When you dub using the same VCR again, you can skip steps 2 and 3.

### Using the Digital program editing on tapes recorded on other equipment

**Operation 1** Making a program (p. 106).

**Operation 2** Performing the program (dubbing a tape) (p. 108).

#### Note

When editing digital video on tapes, the operation signals cannot be sent with the  LANC.

## Step 1: Connecting the VCR

You can connect both an A/V connecting cable and an i.LINK cable.

When you use the A/V connecting cable, connect the devices as illustrated on page 95.

When you use the i.LINK cable, connect the devices as illustrated on page 97.

#### If you connect using the i.LINK cable

With a digital-to-digital connection, video and audio signals are transmitted in digital form for high-quality editing.

# Dubbing only desired scenes – Digital program editing (on tapes)

## Step 2: Setting the VCR to operate with the A/V connecting cable

To edit using the VCR, send the control signal by infrared rays to the remote sensor on the VCR.

When you connect using the A/V connecting cable, follow the procedure below, steps (1) to (4), to send the control signal correctly.

### (1) Set the IR SETUP code

- ① Set the POWER switch to VCR on your camcorder.
- ② Turn the power of the connected VCR on, then set the input selector to LINE.  
When you connect a video camera recorder, set its power switch to VCR/VTR.
- ③ Press MENU, then turn the SEL/PUSH EXEC dial to set VIDEO EDIT in **ETC** to TAPE, then press the dial (p. 217).
- ④ Turn the SEL/PUSH EXEC dial to select EDIT SET, then press the dial.
- ⑤ Turn the SEL/PUSH EXEC dial to select CONTROL, then press the dial.
- ⑥ Turn the SEL/PUSH EXEC dial to select IR, then press the dial.
- ⑦ Turn the SEL/PUSH EXEC dial to select IR SETUP and turn the dial to select IR SETUP code number of your VCR, then press the dial.  
Check the code in "About IR SETUP codes." (p. 100)

Editing

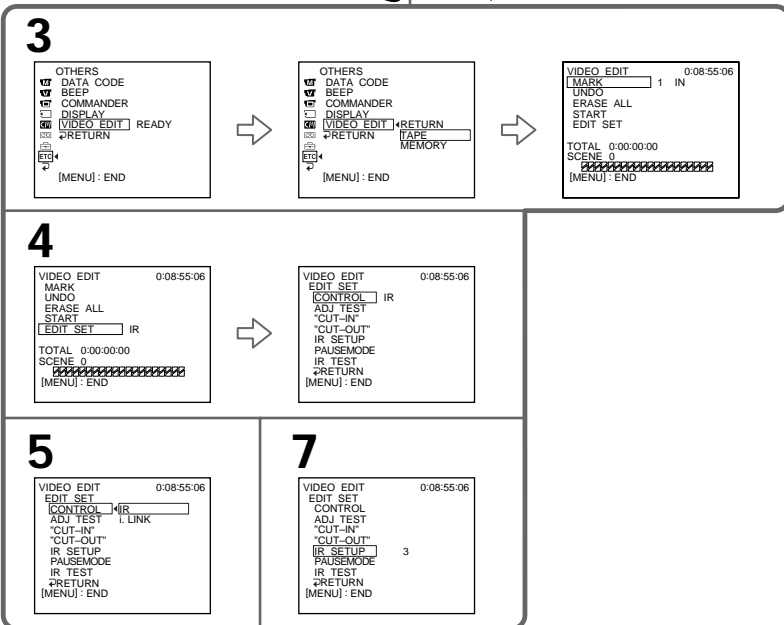
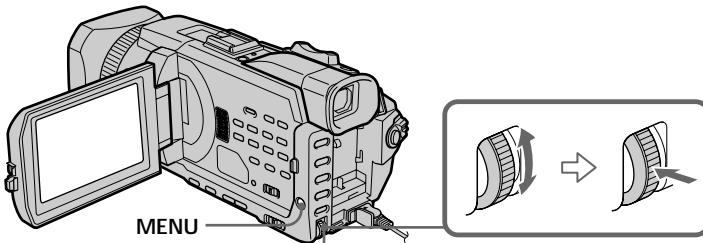

## Dubbing only desired scenes – Digital program editing (on tapes)

### About IR SETUP codes

The IR SETUP code is stored in the memory of your camcorder. Be sure to set the correct code to match your VCR. The default setting is code number 3.

Brand	IR SETUP code
Sony	1, 2, 3, 4, 5, 6
Admiral (M. Wards)	89
Aiwa	47, 54, 80
Akai	49, 51
Audio Dynamic	21, 35
Bell&Howell (M. Wards)	36
Broksonic	21, 70, 82
Canon	77, 78
Citizen	47
Craig	47, 73
Curtis Mathis	8, 77, 80
Daewoo	26, 40, 77
DBX	21, 33, 35
Dimensia	8
Emerson	26, 48, 59, 70, 80, 81, 82
Fisher	36, 37, 44, 45
Funai	80
General Electric	8, 32*, 77, 94*, 101
Goldstar/LG	47
GO VIDEO	71
Hitachi	8, 42, 78
HQ	40
Instant Replay	77, 78
JC Penny	8, 21, 33, 35, 36, 42, 77
JVC	12, 13, 14, 21, 33, 35
Kenwood	21, 33, 35, 47
LXI (Sears)	36, 37, 42, 44, 45, 47, 49, 80
Magnavox	17, 77, 78, 83
Marantz	21, 33, 35
Marta	47
Memorex	37, 77
Minolta	8, 42

Brand	IR SETUP code
Mitsubishi/MGA	22, 23, 24, 28, 29
Multitech	23, 32, 80
NEC	21, 33, 35
Olympic	77, 78
Optimus	22
Orion	60
Panasonic	16, 17, 77, 78
Pentax	8, 42
Philco	26, 70, 77, 78
Philips	47, 77, 78, 83
Pioneer	78
Quasar	6, 16, 17, 77, 78
RCA/PROSCAN	7, 8, 16, 40, 41, 42, 77, 78, 78*, 83, 101
Realistic	22, 36, 37, 77, 80, 88
Sansui	21
Singer	73
Samsung	24, 24*, 32, 32*, 41, 94, 94*
Sanyo	26, 36, 37, 47
Scott	22, 23, 24, 28, 32, 37, 40, 41
Sharp	88, 89
Shintom	73
Signature 2000	80, 89
Sylvania	77, 78, 80, 83
Symphonic	80
Tashiro	47
Tatung	21, 33, 35
Teac	21, 33, 35, 80
Technics	77, 78
Toshiba	7, 40, 49
Wards	37, 47, 88, 89, 95
Yamaha	21, 33, 35, 36
Zenith	95

\* TV/VCR component

### Note on IR SETUP codes

Digital program editing is not possible if the VCR does not support IR SETUP codes.

## Dubbing only desired scenes – Digital program editing (on tapes)

### (2) Setting the modes to cancel the recording pause on the VCR

- ① Turn the SEL/PUSH EXEC dial to select PAUSEMODE, then press the dial.
- ② Turn the SEL/PUSH EXEC dial to select the mode to cancel recording pause on the VCR, then press the dial.

Refer to the operating instructions of your VCR.

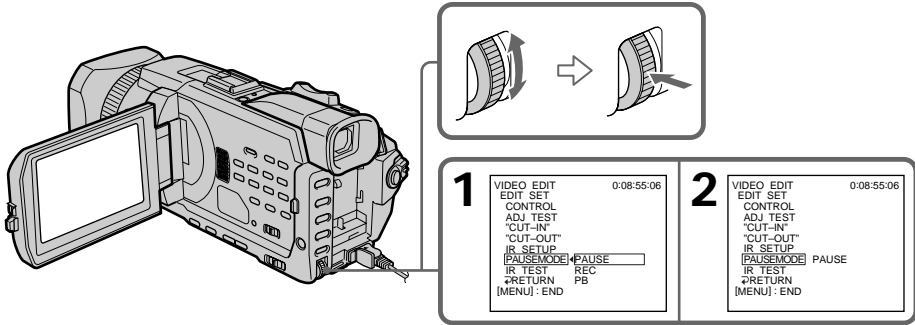

### Buttons to cancel recording pause on the VCR

The buttons vary depending on your VCR. To cancel recording pause:

- Select PAUSE if the button to cancel recording pause is **II**.
- Select REC if the button to cancel recording pause is **●**.
- Select PB if the button to cancel recording pause is **▶**.

### (3) Setting your camcorder and the VCR to face each other

Locate the infrared rays emitter of your camcorder and face it towards the remote sensor of the VCR.

Set the devices about 30 cm (12 in.) apart, and remove any obstacles between the devices.

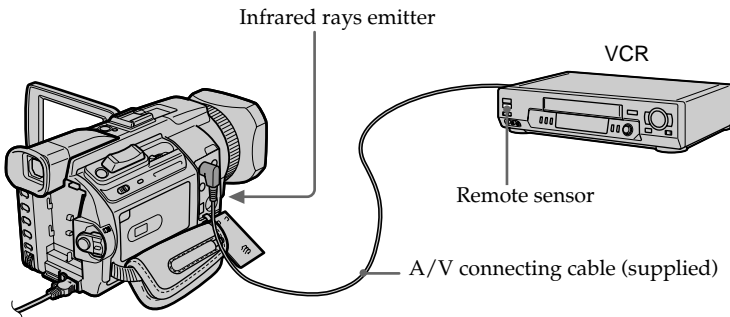

## Dubbing only desired scenes – Digital program editing (on tapes)

### (4) Confirming VCR operation

- ① Insert a recordable tape into the VCR, then set to recording pause.
- ② Turn the SEL/PUSH EXEC dial to select IR TEST, then press the dial.
- ③ Turn the SEL/PUSH EXEC dial to select EXECUTE, then press the dial.

If the VCR starts recording, the setting is correct.

When recording is finished, the indicator changes to COMPLETE.

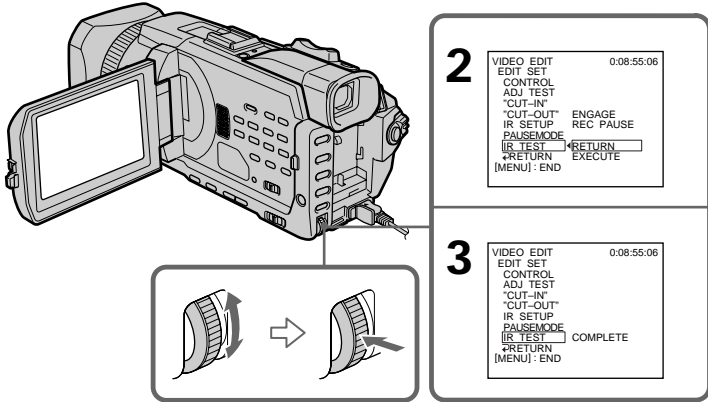

### When the VCR does not operate correctly

- After checking the code in "About IR SETUP codes", set the IR SETUP or the PAUSEMODE again.
- Place your camcorder at least 30 cm (12 in.) away from the VCR.
- Refer to the operating instructions of your VCR.

# Dubbing only desired scenes – Digital program editing (on tapes)

## Step 2: Setting the VCR to operate with the i.LINK cable

When you connect using the i.LINK cable (optional), follow the procedure below.

- (1) Set the POWER switch to VCR on your camcorder.
- (2) Turn the power of the connected VCR on, then set the input selector to DV input. When you connect a digital video camera recorder, set its power switch to VCR/VTR.
- (3) Press MENU, then turn the SEL/PUSH EXEC dial to set VIDEO EDIT in **ETC** to TAPE, then press the dial (p. 217).
- (4) Turn the SEL/PUSH EXEC dial to select EDIT SET, then press the dial.
- (5) Turn the SEL/PUSH EXEC dial to select CONTROL, then press the dial.
- (6) Turn the SEL/PUSH EXEC dial to select i.LINK, then press the dial.

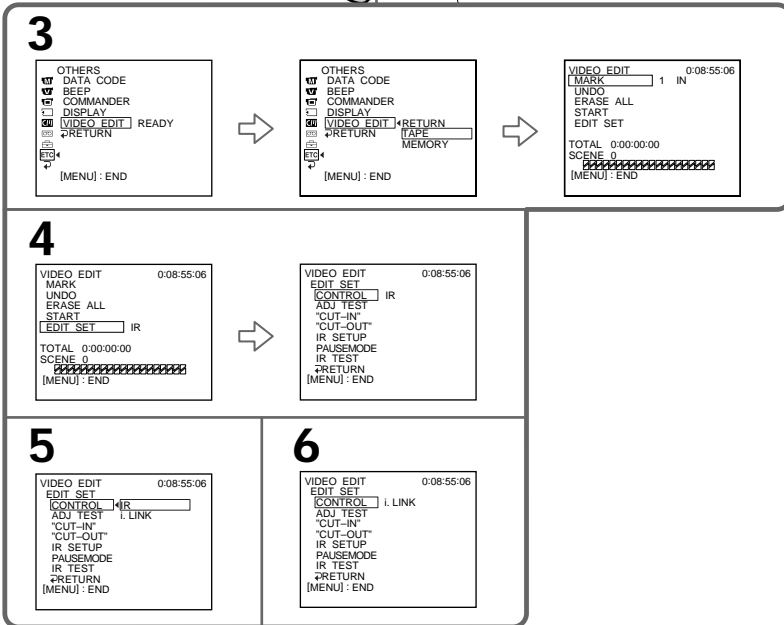
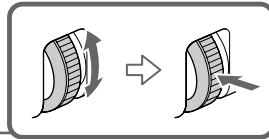
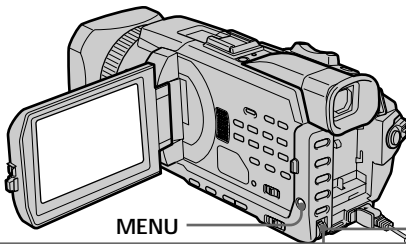

When you connect using an i.LINK cable  
You cannot dub the titles, display indicators.

### Step 3: Adjusting the synchronization of the VCR

You can adjust the synchronization of your camcorder and the VCR. Have a pen and paper ready for notes. Before operation, eject a cassette from your camcorder.

- (1) Insert a blank tape (or a tape you want to record over) into the VCR, then set to recording pause.  
When you select i.LINK in CONTROL, you do not need to set to recording pause.
- (2) Turn the SEL/PUSH EXEC dial to select ADJ TEST, then press the dial.
- (3) Turn the SEL/PUSH EXEC dial to select EXECUTE, then press the dial.  
IN and OUT are recorded on an image for five times each to calculate the number values for adjusting the synchronization.  
The EXECUTING indicator flashes on the screen.  
When finished, the indicator changes to COMPLETE.
- (4) Rewind the tape in the VCR, then start slow playback.  
Take a note of the first number value of each IN and the closing number value of each OUT.
- (5) Calculate the average of all the first number values of each IN, and the average of all the last number values of each OUT.
- (6) Turn the SEL/PUSH EXEC dial to select "CUT-IN", then press the dial.
- (7) Turn the SEL/PUSH EXEC dial to select the average number value of IN, then press the dial.  
The calculated start position for recording is set.
- (8) Turn the SEL/PUSH EXEC dial to select "CUT-OUT", then press the dial.
- (9) Turn the SEL/PUSH EXEC dial to select the average number value of OUT, then press the dial.  
The calculated stop position for recording is set.
- (10) Turn the SEL/PUSH EXEC dial to select ↶ RETURN, then press the dial.



## Dubbing only desired scenes – Digital program editing (on tapes)

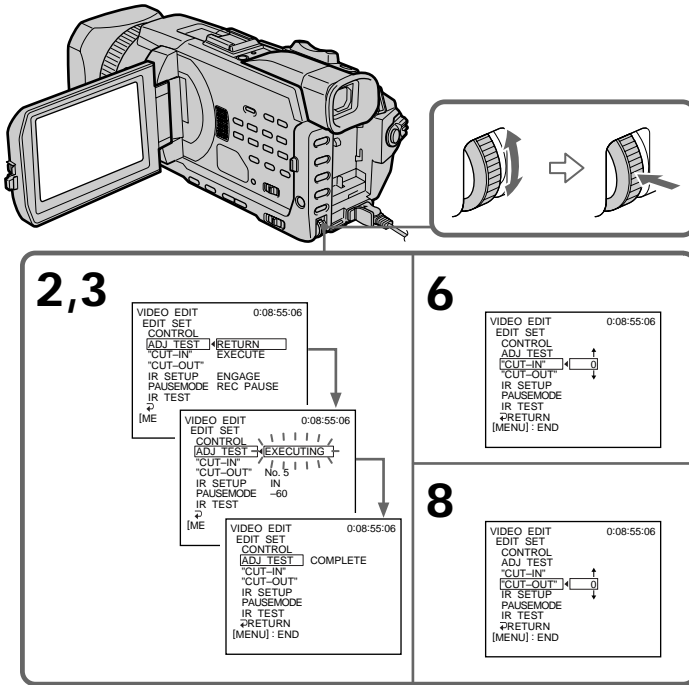

### Notes

- When you complete step 3, the image used to adjust the synchronization is recorded for about 50 seconds.
- If you start recording from the very beginning of the tape, the first few seconds of the tape may not record properly. Be sure to allow about 10 seconds' lead before starting recording.
- When the recording unit cannot be operated properly by the i.LINK cable, leave the connection as it is, and make the A/V connecting cable settings (p. 99). Video and audio are sent by digital signals.

# Dubbing only desired scenes – Digital program editing (on tapes)

## Operation 1: Making a program

- (1) Insert the tape for playback into your camcorder, and insert a tape for recording into the VCR.
- (2) Press MENU, then turn the SEL/PUSH EXEC dial to set VIDEO EDIT in **ETC** to TAPE, then press the dial (p. 217).
- (3) Search for the beginning of the first scene you want to insert using the video operation buttons, then pause playback. You can fine-adjust one frame at a time with EDITSEARCH.
- (4) Press MARK on the Remote Commander, or turn the SEL/PUSH EXEC dial to select MARK, then press the dial. The IN point of the first program is set, and the top part of the program mark changes to light blue.
- (5) Search for the end of the first scene you want to insert using the video operation buttons, then pause playback. You can fine-adjust one frame at a time with EDITSEARCH.
- (6) Press MARK on the Remote Commander, or the SEL/PUSH EXEC dial. The OUT point of the first program is set, then the bottom part of the program mark changes to light blue.
- (7) Repeat steps 3 to 6, then set the program. When the program is set, the program mark changes to light blue. You can set up to 20 programs in maximum.

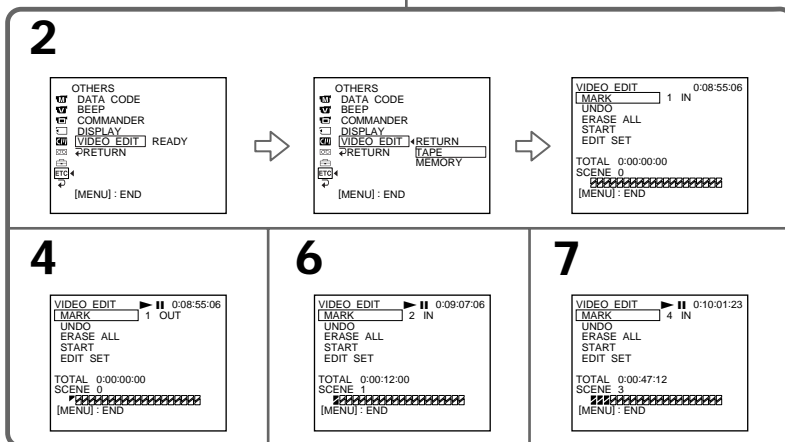
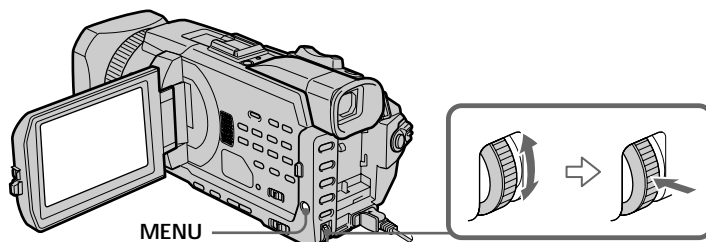

## Dubbing only desired scenes – Digital program editing (on tapes)

---

### Erasing the program you have set

Erase OUT first and then IN from of the last program.

- (1) Turn the SEL/PUSH EXEC dial to select UNDO, then press the dial.
- (2) Turn the SEL/PUSH EXEC dial to select EXECUTE, then press the dial.  
The last set program mark flashes, then the setting is canceled.

### To cancel erasing

Select RETURN with the SEL/PUSH EXEC dial in step 2.

### Erasing all programs

- (1) Turn the SEL/PUSH EXEC dial to select ERASE ALL.
- (2) Turn the SEL/PUSH EXEC dial to select EXECUTE, then press the dial.  
All the program marks flash, then the settings are canceled.

### To cancel erasing all programs

Select RETURN with the SEL/PUSH EXEC dial in step 2.

### To cancel a program you have set

Press MENU.

The program is stored in memory until the tape is ejected.

---

### Note

You cannot operate recording during Digital program editing.

### If the tape has a blank portion

You cannot set IN and OUT on the portion.

### If there is a blank portion between IN and OUT on the tape

The total time code may not be displayed correctly.

## Dubbing only desired scenes – Digital program editing (on tapes)

---

### Operation 2: Performing the program (Dubbing a tape)

Make sure that your camcorder and the VCR are connected, and that the VCR is set to recording pause. When you use an i.LINK cable, the following procedure is not necessary.

When you use a digital video camera recorder, set its power switch to VCR/VTR.

- (1) Turn the SEL/PUSH EXEC dial to select START.
- (2) Turn the SEL/PUSH EXEC dial to select EXECUTE, then press the dial.

Search for the beginning of the first program, then start dubbing.

The program mark flashes.

The SEARCH indicator appears during search, and the EDITING indicator appears during edit on the screen.

The PROGRAM indicator changes to light blue after dubbing ends.

When dubbing ends, your camcorder and the VCR automatically stop.

#### To stop dubbing during editing

Press ■ using the video operation buttons.

#### To end the Digital program editing

Your camcorder stops when the dubbing ends. Then the display returns to VIDEO EDIT in the menu settings.

Press MENU to erase the menu display.

---

#### You cannot record on the VCR when:

- The tape has run out.
- The write-protect tab on the cassette is set to lock.
- The IR SETUP code is not correct. (when IR is selected)
- The button to cancel recording pause is not correct. (when IR is selected)

#### NOT READY appears on the LCD screen when:

- The program to operate the Digital program editing has not been made.
- i.LINK is selected but an i.LINK cable is not connected.
- The power of the connected VCR is not turned on. (when you set i.LINK)

# Recording video or TV programs

## Using the A/V connecting cable

You can record a tape from another VCR or a TV program from a TV that has video/audio outputs. Use your camcorder as a recorder.

### Before operation

Set DISPLAY in **[ETC]** to LCD in the menu settings. (The default setting is LCD.)

- (1) Insert a blank tape (or a tape you want to record over) into your camcorder. If you are recording a tape from the VCR, insert a recorded tape into the VCR.
- (2) Set the POWER switch to VCR on your camcorder.
- (3) Press ● REC and the button on its right simultaneously on your camcorder, then immediately press || on your camcorder.
- (4) Press ► on the VCR to start playback if you record a tape from a VCR. Select a TV program if you are recording from a TV. The picture from a TV or VCR appears on the screen.
- (5) Press || on your camcorder at the scene where you want to start recording from.

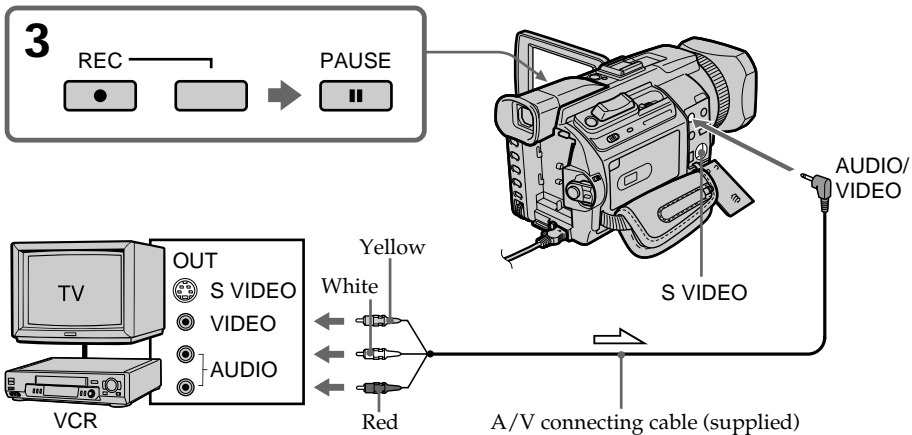

➔ : Signal flow

## When you have finished dubbing a tape

Press ■ on both your camcorder and the VCR.

## Using the Remote Commander

In step 3, press ● REC and MARK simultaneously, then immediately press ||. In step 5, press || at the scene where you want to start recording from.

## Recording video or TV programs

---

### **If your TV or VCR is a monaural type**

Connect the yellow plug of the A/V connecting cable to the video output jack and the white or the red plug to the audio output jack on the VCR or the TV. When the white plug is connected, the left channel audio is output, and when the red plug is connected, the right channel audio is output.

### **If your TV or VCR has an S video jack**

Pictures can be reproduced more faithfully by using an S video cable (optional).

With this connection, you do not need to connect the yellow (video) plug of the A/V connecting cable.

Connect an S video cable (optional) to the S video jacks of both your camcorder and the TV or VCR.

This connection produces higher quality DV format pictures.

### **Note on the Remote Commander**

Your camcorder works in the commander mode VTR 2. Commander modes 1, 2 and 3 are used to distinguish your camcorder from other Sony VCRs to avoid erroneous remote control operation. If you use another Sony VCR in the commander mode VTR 2, we recommend changing the commander mode or covering the sensor of the VCR with black paper.

## Recording video or TV programs

### Using the i.LINK cable

Simply connect the i.LINK cable (optional) to the **i** DV Interface on your camcorder and to DV OUT on the DV products. With a digital-to-digital connection, video and audio signals are transmitted in digital form for high-quality editing.

- (1) Insert a blank tape (or a tape you want to record over) into your camcorder, and insert the recorded tape into the VCR.
- (2) Set the POWER switch to VCR on your camcorder.
- (3) Press ● REC and the button on its right simultaneously on your camcorder, then immediately press || on your camcorder.
- (4) Press ► on the VCR to start playback. The picture to be recorded appears on the screen.
- (5) Press || on your camcorder at the scene where you want to start recording from.

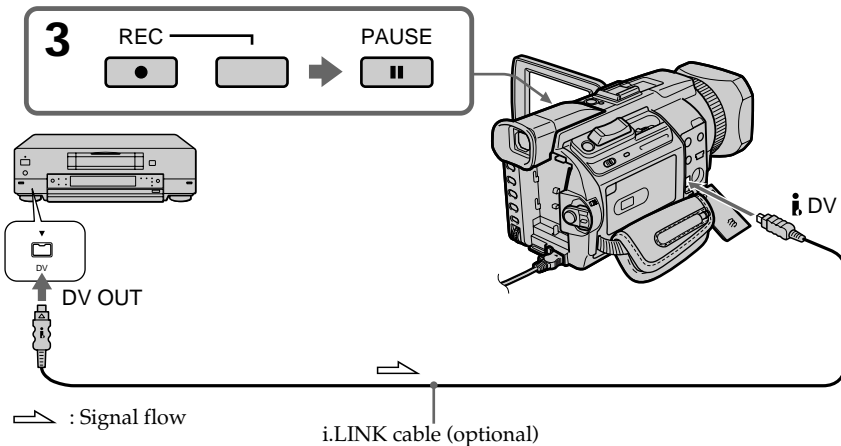

### When you have finished dubbing a tape

Press ■ on both your camcorder and the VCR.

### Using the Remote Commander

In step 3, press ● REC and MARK simultaneously, then immediately press ||. In step 5, press || at the scene where you want to start recording from.

## Recording video or TV programs

---

**You can connect one VCR only using the i.LINK cable**

### **During digital editing**

The color of the display may be uneven. However, this does not affect the dubbed picture.

### **If you record playback pause picture with the DV Interface**

The recorded picture becomes rough. When you play back the picture using your camcorder, the picture may jitter.

### **Before recording**

Make sure that the DV IN indicator appears on the LCD screen or in the viewfinder. The DV IN indicator may appear on both equipment.

### **Note on the Remote Commander**

Your camcorder works in the commander mode VTR 2. Commander modes 1, 2 and 3 are used to distinguish your camcorder from other Sony VCRs to avoid erroneous remote control operation. If you use another Sony VCR in the commander mode VTR 2, we recommend changing the commander mode or covering the sensor of the VCR with black paper.



# Inserting a scene from a VCR - Insert Editing

You can insert a new scene from a VCR onto your originally recorded tape by specifying the insert start and end points. Use the Remote Commander for this operation. Connections are the same as on page 109 or 111.

Insert a cassette containing the desired scene to insert into the VCR.

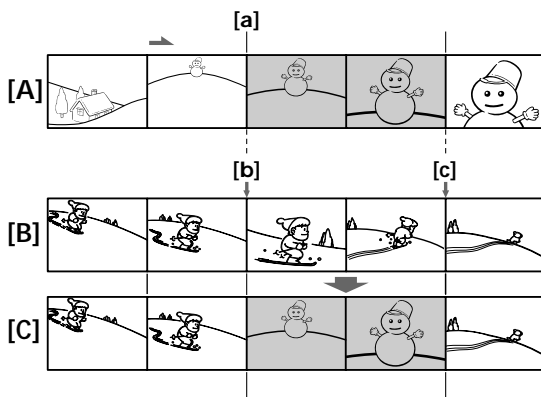

[A]: A tape that contains the scene to be superimposed

[B]: A tape before editing

[C]: A tape after editing

- (1) Set the POWER switch to VCR on your camcorder.
- (2) On the connected VCR, locate just before the insert start point [a], then press **II** to set the VCR to the playback pause.
- (3) On your camcorder, locate the insert end point [c]. Then press **II** to set your camcorder to the playback pause.
- (4) Press ZERO SET MEMORY on the Remote Commander. The ZERO SET MEMORY indicator flashes and the end point of the insert is stored in memory. The tape counter shows "0:00:00."
- (5) On your camcorder, locate the insert start point [b] by pressing **◀◀**, then press **● REC** and the button on its right simultaneously.
- (6) First press **II** on the VCR, and after a few seconds press **II** on your camcorder to start inserting the new scene.  
Inserting automatically stops near the zero point on the tape counter. Your camcorder automatically returns to the recording pause.

## Inserting a scene from a VCR – Insert Editing

---

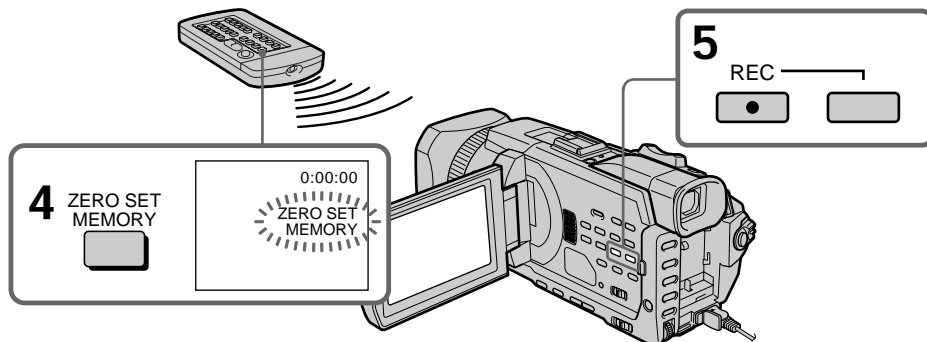

### To change the insert end point

Press ZERO SET MEMORY again after step 5 to erase the ZERO SET MEMORY indicator and begin from step 3.

### Using the Remote Commander

In step 5, press ● REC and MARK simultaneously, then immediately press ■. In step 6, press ■ at the scene where you want to start recording from.

---

#### Note

Pictures and sound recorded on the portion between the insert start and end points will be erased when you insert the new scene.

#### If you insert scenes on the tape recorded on another camcorder (including another DCR-TRV940/TRV950)

The pictures and sound may be distorted. We recommend that you insert scenes on a tape recorded on your camcorder.

#### When the inserted picture is played back

Pictures and sound may be distorted at the end of the inserted portion. This is not a malfunction.

Pictures and sound at the start point and the end point may be distorted in the LP mode.

#### To insert a scene without setting the insert end point

Skip steps 3 and 4. Press ■ when you want to stop inserting.

#### If you press FN

The ZERO SET MEMORY indicator is not display.

#### Note on the Remote Commander

Your camcorder works in the commander mode VTR 2. Commander modes 1, 2 and 3 are used to distinguish your camcorder from other Sony VCRs to avoid erroneous remote control operation. If you use another Sony VCR in the commander mode VTR 2, we recommend changing the commander mode or covering the sensor of the VCR with black paper.

# Audio dubbing

You can record audio to add to the original sound on a tape by connecting audio equipment or a microphone. If you connect audio equipment, you can add sound to your recorded tape already recorded in the 12-bit mode by specifying the start and end points. The original sound will not be erased.

Use the Remote Commander for this operation.

Select one of the following connections to add audio.

## Connecting the microphone with the MIC jack

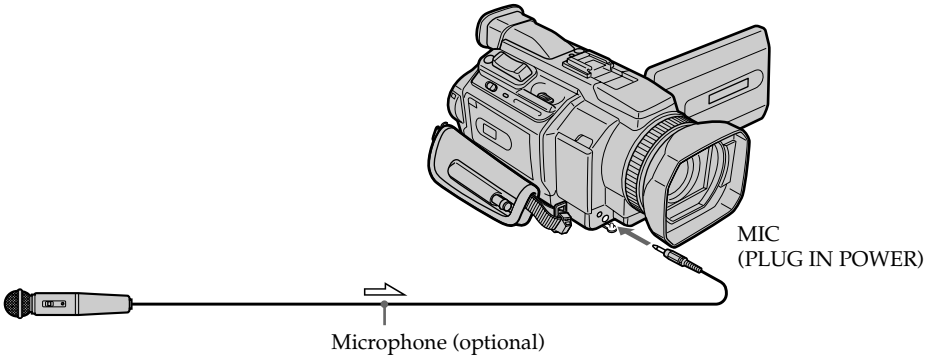

 : Signal flow

You can check recorded picture and sound by connecting your camcorder to a TV with the A/V connecting cable.

Recorded sound is not output from a speaker. Check the sound by using a TV or headphones.

## Connecting the microphone to the intelligent accessory shoe

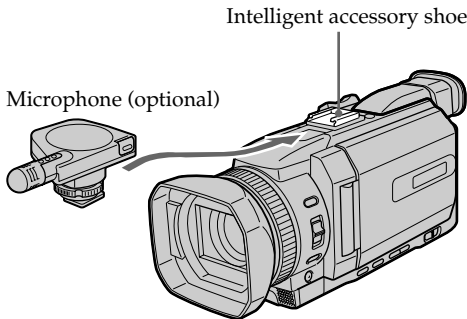

## Audio dubbing

### Connecting the A/V connecting cable to the AUDIO/VIDEO jack

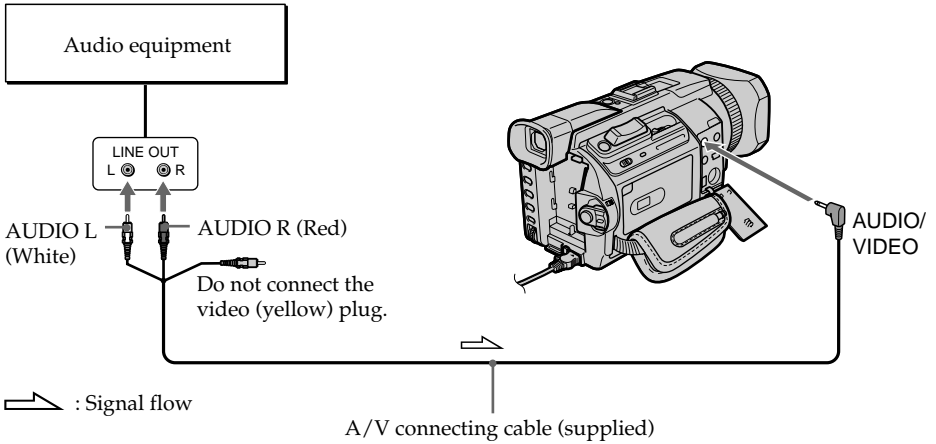

### Dubbing with the built-in microphone

No connection is necessary.

#### Notes

- When dubbing with the AUDIO/VIDEO jack or the built-in microphone, pictures are not output through the S VIDEO jack or the AUDIO/VIDEO jack. Check the recorded picture on the screen. You can check the recorded sound by using headphones.
- You cannot add audio with the DV Interface.

#### If you make all the connections

The audio input to be recorded will take precedence over others in the following order:

- MIC (PLUG IN POWER) jack
- Intelligent accessory shoe
- AUDIO/VIDEO jack
- Built-in microphone

### Adding audio on a recorded tape

Choose a connection described on the previous pages, and connect audio equipment or microphone to your camcorder. Then follow the procedure below.

- (1) Insert the recorded tape into your camcorder.
- (2) Set the POWER switch to VCR on your camcorder.
- (3) Locate the recording start point by pressing ►. Then press || at the point where you want to start recording to set your camcorder to the playback pause.
- (4) Press AUDIO DUB . The green ●|| indicator appears on the screen.
- (5) Press || and start playing back the audio you want to record at the same time. The new sound is recorded in stereo 2 (ST2) during playback. While audio is being recorded, the red ● appears on the screen.
- (6) Press ■ at the point where you want to stop recording.

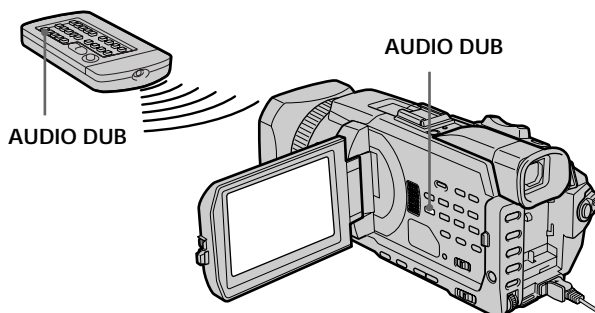

#### When you dub the recorded sound

You can adjust the recorded sound by using MIC LEVEL (p. 79). However, when the camcorder is connected to the AUDIO/VIDEO jack, sound cannot be adjusted.

#### To add audio more precisely

Press ZERO SET MEMORY on the Remote Commander at the point where you want to stop recording later in the playback.

Carry out from steps 3 to 5. Recording automatically stops at the point where ZERO SET MEMORY was pressed.

## Audio dubbing

### Monitoring the new recorded sound

- (1) Play back the tape on which you added audio.
- (2) Turn the SEL/PUSH EXEC dial to select AUDIO MIX in  in the menu settings, then press the dial.

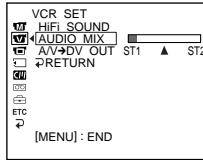

- (3) Turn the SEL/PUSH EXEC dial to adjust the balance between the original sound (ST1) and the new sound (ST2), then press the dial.

Five minutes after you remove the power supply or the battery pack, the AUDIO MIX setting returns to original sound (ST1) only. The default setting is original sound only.

#### Notes

- New audio cannot be recorded on a tape already recorded in the 16-bit mode (32 kHz, 44.1 kHz or 48 kHz).
- New audio cannot be recorded on a tape already recorded in the LP mode.
- You cannot add audio on the blank portion of the tape.

#### If an i.LINK cable (optional) is connected to your camcorder

You cannot add audio to a recorded tape.

#### We recommend that you add audio on a tape recorded with your camcorder

If you add audio on a tape recorded with another camcorder (including another DCR-TRV940/TRV950), the sound quality may become worse.

#### If you set the write-protect tab of the cassette to lock

You cannot record on a tape. Slide the write-protect tab to release the write protection.

# Superimposing a title

CM  
only

If you use a tape with cassette memory, you can superimpose the title. When you play back the tape, the title is displayed for five seconds from the point where you superimposed it.



- (1) In the recording, recording standby, playback or playback pause, press MENU, then select TITLE in with the SEL/PUSH EXEC dial (p. 213).
- (2) Turn the SEL/PUSH EXEC dial to select , then press the dial.
- (3) Turn the SEL/PUSH EXEC dial to select the desired title, then press the dial. The title flashes.
- (4) Change the color, size, or position, if necessary.
  - ① Turn the SEL/PUSH EXEC dial to select COLOR, SIZE or POSITION, then press the dial. The selected item appears.
  - ② Turn the SEL/PUSH EXEC dial to select the desired item, then press the dial.
  - ③ Repeat steps ① and ② until the title is laid out as desired.
- (5) Press the SEL/PUSH EXEC dial again to complete the setting.

In the recording, playback or playback pause:

The TITLE SAVE indicator appears on the screen for five seconds and the title is set.

In the standby:

The TITLE indicator appears. When you press START/STOP to start recording, TITLE SAVE appears on the screen for five seconds, and the title is set.

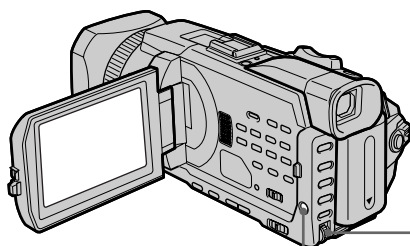

MENU

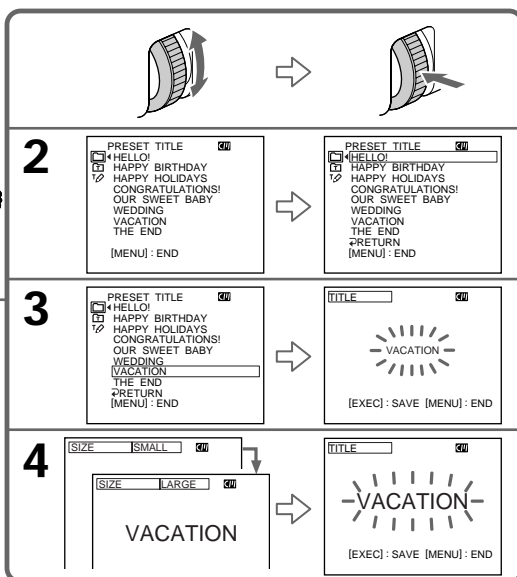

## Superimposing a title

---

### If you set the write-protect tab of the tape to lock

You cannot superimpose or erase the title. Slide the write-protect tab to release the write protection.

### To use a custom title

If you want to use a custom title, select  in step 2.

### If the tape has a blank portion

You cannot superimpose a title on the portion.

### If the tape has a blank portion between recorded portions

Titles may not be displayed correctly.

### Titles superimposed with your camcorder

- Titles are displayed by only the <sup>Mini</sup> DV format video equipment with an index titler.
- The point you superimposed the title may be detected as an index signal when searching a recording with other video equipment.

### If the tape has too many index signals

You may not be able to superimpose a title because memory becomes full. In this case, delete data you do not need.

### To not display titles

Set TITLE DSPL to OFF in the menu settings (p. 213).

### Title setting

- The title color changes as follows:

WHITE ↔ YELLOW ↔ VIOLET ↔ RED ↔ CYAN ↔ GREEN ↔ BLUE

- The title size changes as follows:

SMALL ↔ LARGE

You cannot input 13 characters or more in LARGE size. If you input more than 12 characters, the title size returns to SMALL even if you select LARGE.

- If you select SMALL, you have nine choices for the title position.  
If you select LARGE, you have eight choices for the title position.

### One cassette can have up to about 20 titles, with each title comprising five characters

However, if the cassette memory is full with date, photo and cassette label data, one cassette can have only up to about 11 titles each comprising five characters.

Cassette memory capacity is as follows:

- six date data
- 12 photo data
- one cassette label

### If the "FULL" mark appears

The cassette memory is full. Erase unwanted titles.



## Superimposing a title

### Erasing a title

- (1) Set the POWER switch to CAMERA or VCR.
- (2) Press MENU, then turn the SEL/PUSH EXEC dial to select TITLEERASE in , then press the dial (p. 213).
- (3) Turn the SEL/PUSH EXEC dial to select the title you want to erase, then press the dial. ERASE OK ? indicator appears.
- (4) Make sure that the title is the one you want to erase, and turn the SEL/PUSH EXEC dial to select OK, then press the dial. OK changes to EXECUTE.
- (5) Turn the SEL/PUSH EXEC dial to select EXECUTE, then press the dial. The ERASING flashes on the screen. When the title is erased, the COMPLETE is displayed.

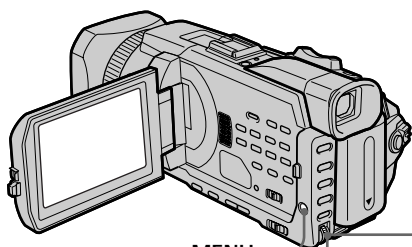

MENU

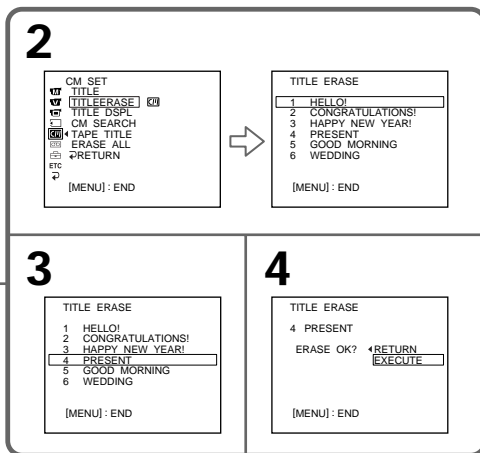
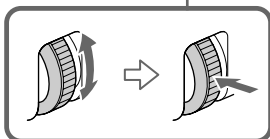



### To cancel erasing a title

Select RETURN in step 4 or 5.

# Making your own titles

You can make up to two titles and store them in the memory of your camcorder. Each title can have up to 20 characters.

- (1) Set the POWER switch to CAMERA or VCR.
- (2) Press MENU, then turn the SEL/PUSH EXEC dial to select TITLE in , then press the dial (p. 213).
- (3) Turn the SEL/PUSH EXEC dial to select , then press the dial.
- (4) Turn the SEL/PUSH EXEC dial to select CUSTOM1 SET or CUSTOM2 SET, then press the dial.
- (5) Turn the SEL/PUSH EXEC dial to select the column of the desired character, then press the dial.
- (6) Turn the SEL/PUSH EXEC dial to select the desired character, then press the dial.
- (7) Repeat steps 5 and 6 until you have selected all characters and completed the title.
- (8) To finish making your own titles, turn the SEL/PUSH EXEC dial to select [SET], then press the dial.

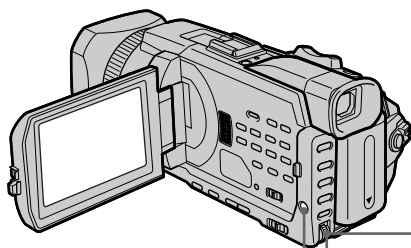

MENU

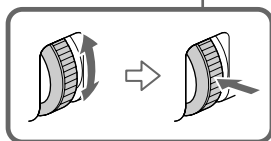

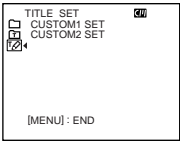
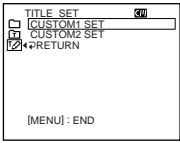
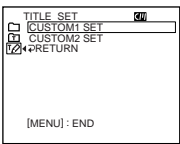
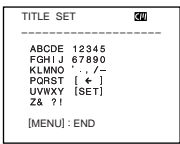
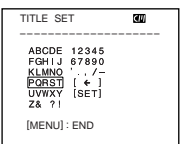
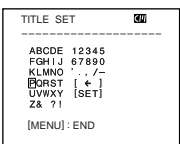
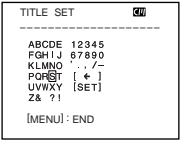
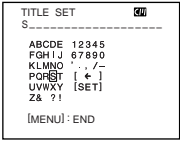
<b>3</b>		
<b>4</b>		
<b>5</b>		
<b>7</b>		

## Making your own titles

---

### To change a title you have stored

In step 4, select CUSTOM1 SET or CUSTOM2 SET, depending on which title you want to change, then press the SEL/PUSH EXEC dial. Turn the SEL/PUSH EXEC dial to select [←], then press the dial to delete the title. The last character is erased. Enter the new title as desired.

---

### If you take five minutes or longer to enter characters in the standby while a cassette is set in your camcorder

The power automatically goes off. The characters you have entered remain stored in memory. Set the POWER switch to OFF (CHG) once and then to CAMERA again, then proceed from step 1.

We recommend setting the POWER switch to VCR or removing the cassette so that your camcorder does not automatically turn off while you are entering title characters.

### To delete the title

Select [←]. The last character is erased.

### To enter a space

Select [ Z& ? ! ], then select the blank part.

# Labeling a cassette

CM only

If you use a cassette with cassette memory, you can label a cassette. Labels can consist of up to 10 characters and is stored in cassette memory. When you insert the labeled cassette and when the POWER switch is set to CAMERA or VCR, the label is displayed for about five seconds.

- (1) Insert the cassette you want to label.
- (2) Set the POWER switch to CAMERA or VCR.
- (3) Press MENU, then turn the SEL/PUSH EXEC dial to select TAPE TITLE in **CM**, then press the dial (p. 213). Tape title display appears.
- (4) Turn the SEL/PUSH EXEC dial to select the column of the desired character, then press the dial.
- (5) Turn the SEL/PUSH EXEC dial to select the desired character, then press the dial.
- (6) Repeat steps 4 and 5 until you finish the label.
- (7) Turn the SEL/PUSH EXEC dial to select [SET], then press the dial.  
The label is stored in the memory.

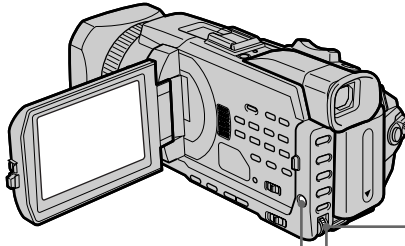

MENU

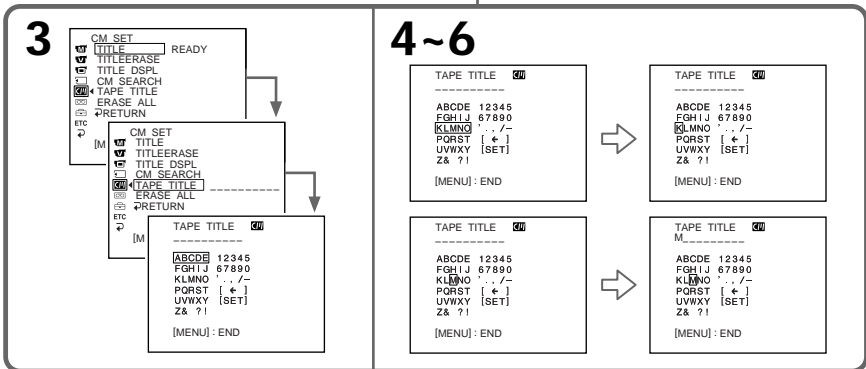
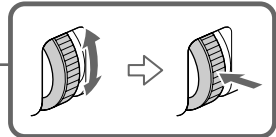

## Labeling a cassette

### To erase the label you have made

In step 4 turn the SEL/PUSH EXEC dial to select [←], then press the dial. The last character is erased.

### To change the label you have made

Insert the cassette to change the label, and operate in the same way to make a new label.

### If you set the write-protect tab of the cassette to lock

You cannot label the tape. Slide the write-protect tab to release the write protection.

### If the tape has too many index signals

You may not be able to label a cassette because the cassette memory becomes full. In this case, delete data you do not need.

### If you have superimposed titles in the cassette

When the label is displayed, up to four titles also appear.

### When the “-----” indicator has fewer than 10 spaces

The cassette memory is full.

The “-----” indicates the number of characters you can select for the label.

### To delete the title

Select [←]. The last character is erased.

### To enter a space

Select [ Z& ?! ], then select the blank part.

## Erasing all the data in cassette memory

You can erase all the data in cassette memory at once.

- (1) Set the POWER switch to CAMERA or VCR.
- (2) Press MENU, then turn the SEL/PUSH EXEC dial to select ERASE ALL in **CM**, then press the dial (p. 213).
- (3) Turn the SEL/PUSH EXEC dial to select OK, then press the dial. OK changes to EXECUTE.

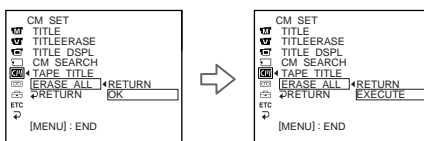

- (4) Turn the SEL/PUSH EXEC dial to select EXECUTE, then press the dial. ERASING flashes on the screen. When all the data is erased, COMPLETE is displayed.

### To cancel deleting

Select RETURN with the SEL/PUSH EXEC dial in step 3 or 4.

# Using a “Memory Stick” – Introduction

You can record and play back images on the “Memory Stick” supplied with your camcorder. You can easily play back, record or delete images. You can exchange image data with other equipment such as your computer etc., using the USB cable for the “Memory Stick” supplied with your camcorder.

## On file format

### Still image (JPEG)

Your camcorder compresses image data in JPEG format (extension .jpg).

### Moving picture (MPEG)

Your camcorder compresses picture data in MPEG format (extension .mpg).

## Typical image data file name

### Still image

100-0001: This file name appears on the screen of your camcorder.

Dsc00001.jpg: This file name appears on the display of your computer.

### Moving picture

MOV00001: This file name appears on the screen of your camcorder.

Mov00001.mpg: This file name appears on the display of your computer.

## Using a “Memory Stick”

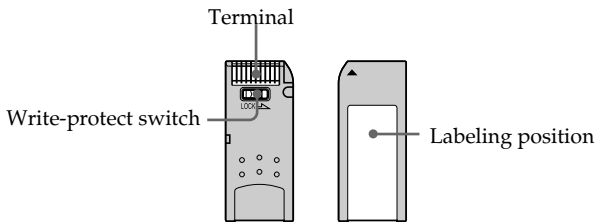

- You cannot record or erase images when the write-protect switch on the “Memory Stick” is set to LOCK.
- The position and shape of the write-protect switch may be different depending on the model.
- We recommend backing up important data on the hard disk of your computer.
- Image data may be damaged in the following cases:
  - If you eject the “Memory Stick” or turn the power off during reading or writing.
  - If you use a “Memory Stick” near static electricity or magnetic fields.
- Prevent metallic objects or your finger from coming into contact with the metal parts of the terminal.
- Stick the label at the labeling position.
- Do not bend, drop or apply strong shock to a “Memory Stick.”
- Do not disassemble or modify a “Memory Stick.”
- Do not let a “Memory Stick” get wet.
- Do not use or keep a “Memory Stick” in locations that are:
  - Extremely hot such as in a car parked in the sun or under the scorching sun.
  - Under direct sunlight
  - Very humid or subject to corrosive gases
- When you carry or store a “Memory Stick,” put it in its case.

## Using a “Memory Stick” – Introduction

---

### “Memory Stick” formatted on computer

The “Memory Stick” formatted on Windows OS or Macintosh computers is not guaranteed compatible with your camcorder.

### Notes on image data compatibility

- Image data files recorded on the “Memory Stick” by your camcorder conform with the Design Rules for Camera File Systems universal standard established by the JEITA (Japan Electronics and Information Technology Industries Association). You cannot play back on your camcorder still images recorded on other equipment (DCR-TRV890E/TRV900/TRV900E or DSC-D700/D770) that does not conform with this universal standard. (These models are not sold in some areas.)
- If you cannot use the “Memory Stick” that is used with other equipment, format it with this camcorder (p. 212). However, formatting erases all information on the “Memory Stick.”

- 
- “Memory Stick” and  are trademarks of Sony Corporation.
  - All other product names mentioned here may be the trademarks or registered trademarks of their respective companies.
- “TM” and “®” are not mentioned in each case in this manual.

## Using a "Memory Stick" - Introduction

### Inserting a "Memory Stick"

- (1) Slide the MEMORY OPEN in the direction of the arrow to open the "Memory Stick" slot.
- (2) Insert a "Memory Stick" in the "Memory Stick" slot as far as it can go with the ► mark facing up as illustrated. Close the "Memory Stick" slot.

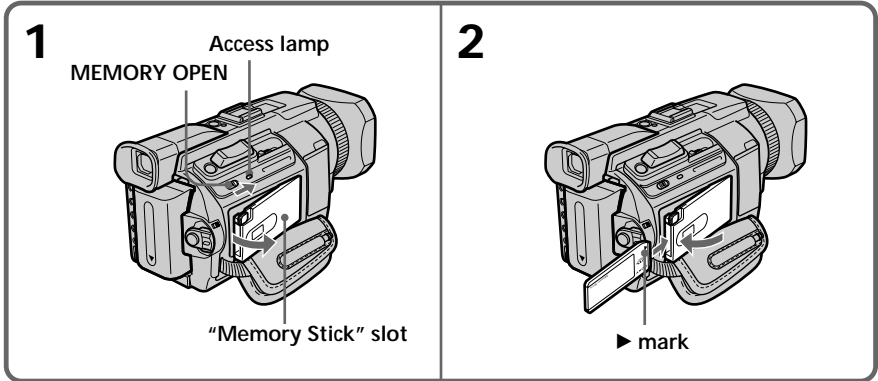

### Ejecting a "Memory Stick"

Press MEMORY EJECT once lightly to eject it.

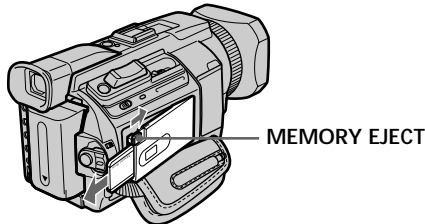

#### While the access lamp is lit or flashing

Do not shake or knock your camcorder because your camcorder is reading the data from the "Memory Stick" or recording the data on the "Memory Stick." Do not turn the power off, eject the "Memory Stick." Otherwise, image data may become damaged.

#### If "MEMORYSTICK ERROR" is displayed

Reinsert the "Memory Stick" a few times. The "Memory Stick" may be damaged if the indicator is still displayed. If this occurs, use another "Memory Stick."



# Using a "Memory Stick" – Introduction

## Using a touch panel

Most operation buttons for use of a "Memory Stick" are displayed on the LCD screen. Touch the LCD screen directly with your finger or the supplied stylus (DCR-TRV950 only) to operate each function.

- (1) Set the POWER switch to MEMORY/NETWORK (DCR-TRV950 only). Make sure that the LOCK switch is set to the further side (unlock position).
- (2) Press OPEN to open the LCD panel. Operation buttons appear on the LCD screen. You can switch the memory playback/memory camera by pressing PLAY/CAM.
- (3) Press FN. Operation buttons appear on the LCD screen.
- (4) Press PAGE2 to go to PAGE2. Operation buttons appear on the LCD screen.
- (5) Press PAGE3 to go to PAGE3. Operation buttons appear on the LCD screen.
- (6) Press a desired operation item.

Refer to relevant pages for each function.

**3~6**

**FN**

In the memory camera

PAGE1	PAGE2	PAGE3	EXIT
↑			
SELF TIMER			
SPOT FOCUS	PLAY	INDEX	SPOT METER

↓

PAGE1	PAGE2	PAGE3	EXIT
↑			
LCD BRT	PLAY	INDEX	MEM M.I.X

↓

PAGE1	PAGE2	PAGE3	EXIT
↑			
SLIDE SHOW	PLAY	INDEX	9PIC PRINT

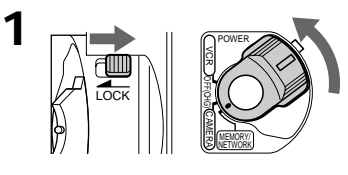
**1**  

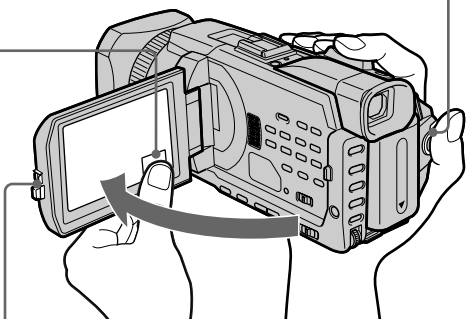

**2**

In the memory camera

PLAY	INDEX	FN

In the memory playback (still image)

-	+	CAM	INDEX	FN

"Memory Stick" Operations

# Using a “Memory Stick” – Introduction

---

## To return to FN

Press EXIT.

## To execute settings

Press  OK.

## To cancel settings

Press  OFF to return to PAGE1/PAGE2/PAGE3.

---

### Notes

- When using the touch panel, press operation buttons with your thumb supporting the LCD screen from the back side of it or press those buttons lightly with your index finger.
- Do not press the LCD screen with sharp-pointed objects other than the supplied stylus. (DCR-TRV950 only)
- Do not press the LCD screen too hard.
- Do not touch the LCD screen with wet hands.
- If FN is not on the LCD screen, touch the LCD screen lightly to make it appear. You can control the display with DISPLAY/TOUCH PANEL on your camcorder.
- When operation buttons do not work even if you press them, an adjustment is required (CALIBRATION) (p. 238).
- When the LCD screen gets dirty, clean it with the supplied cleaning cloth.

### When executing each item

The green bar appears above the item.

### If the items are not available







The color of the items changes to gray.

### Press FN to display the following buttons:

In the memory camera

PAGE1	SELFTIMER, SPOT FOCUS, PLAY, INDEX, SPOT METER
PAGE2	LCD BRT, PLAY, INDEX, MEM MIX
PAGE3	SLIDE SHOW, PLAY, INDEX, 9PIC PRINT

In the memory playback

PAGE1	PB ZOOM, CAM, INDEX, DELETE,  , 
PAGE2	LCD BRT, CAM, INDEX,  , 
PAGE3	SLIDE SHOW, CAM, INDEX, 9PIC PRINT,  , 

# Using a "Memory Stick" – Introduction

## Selecting the still image quality

You can select the image quality in still image recording. The default setting is SUPER FINE.

- (1) Set the POWER switch to MEMORY/NETWORK (DCR-TRV950 only) or VCR. Make sure that the LOCK switch is set to the further side (unlock position).
- (2) Press MENU, then select STILL SET in  with the SEL/PUSH EXEC dial (p. 211).
- (3) Turn the SEL/PUSH EXEC dial to select QUALITY, then press the dial.
- (4) Turn the SEL/PUSH EXEC dial to select the desired image quality, then press the dial.

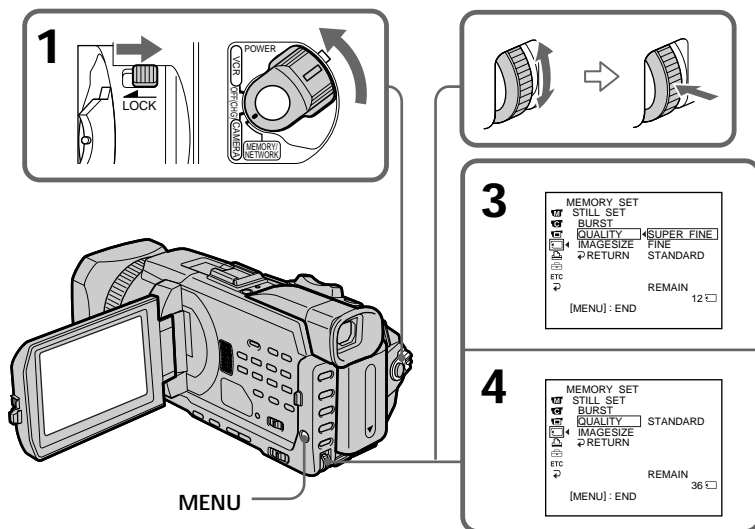

## Using a “Memory Stick” – Introduction

---

### Image quality settings

Setting	Meaning
SUPER FINE (SFN)	This is the highest image quality in your camcorder. The number of still images you can record is less than in FINE mode. Super fine images are compressed to about 1/3.
FINE (FINE)	Use this mode when you want to record high quality images. Fine images are compressed to about 1/6.
STANDARD (STD)	This is the standard image quality in your camcorder. Standard images are compressed to about 1/10.

---

#### Note

In some cases, changing the image quality may not affect the image quality, depending on the type of images you are shooting.

#### Differences in image quality

Recorded images are compressed in JPEG format before being stored in memory. The memory capacity allotted to each image varies depending on the selected image quality and image size. Details are shown in the table below. (You can select 1152 × 864 or 640 × 480 image size in the menu settings.)

#### 1152 × 864 image size

Image quality	Memory capacity
SUPER FINE	About 600 KB
FINE	About 300 KB
STANDARD	About 200 KB

#### 640 × 480 image size

Image quality	Memory capacity
SUPER FINE	About 190 KB
FINE	About 100 KB
STANDARD	About 60 KB

#### Image quality indicator

The image quality indicator is not displayed during playback.

#### When you select image quality

The number of images you can shoot in the currently selected image quality appears on the screen.

# Using a "Memory Stick" – Introduction

## Selecting the image size



You can select either of two image sizes

Still images: 1152 × 864 or 640 × 480. (When the POWER switch is set to CAMERA or VCR, the image size is automatically set to 640 × 480.)  
The default setting is 1152 × 864.

Moving pictures: 320 × 240 or 160 × 112  
The default setting is 320 × 240.

- (1) Set the POWER switch to MEMORY/NETWORK (DCR-TRV950 only). Make sure that the LOCK switch is set to the further side (unlock position).
- (2) Press MENU, then turn the SEL/PUSH EXEC dial to select STILL SET (still image) or MOVIE SET (moving picture) in , then press the dial (p. 211).
- (3) Turn the SEL/PUSH EXEC dial to select IMAGESIZE, then press the dial.
- (4) Turn the SEL/PUSH EXEC dial to select the desired image size, then press the dial.

The indicator changes as follows:



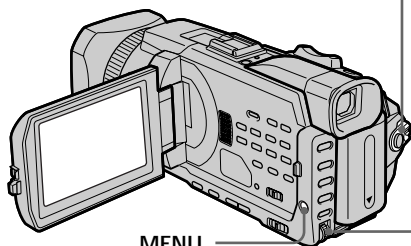
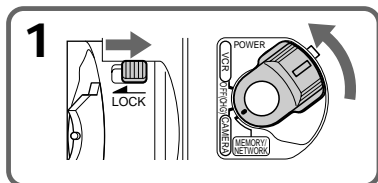

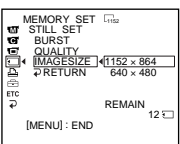
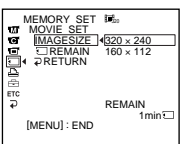
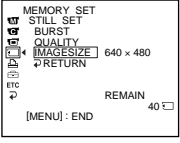
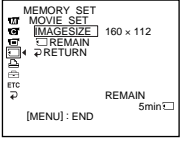
Still images:  ↔   
Moving pictures:  ↔ 



<b>3</b> STILL SET	MOVIE SET
	
<b>4</b> STILL SET	MOVIE SET
	

## Using a “Memory Stick” – Introduction

### Image size settings

Setting	Meaning	Indicator
1152 × 864	Records 1152 × 864 still images.	
640 × 480	Records 640 × 480 still images.	
320 × 240	Records 320 × 240 moving pictures.	
160 × 112	Records 160 × 112 moving pictures.	

### Approximate number of still images you can record on a “Memory Stick”

The number of images you can record varies depending on which image quality and image size you select and the complexity of the subject.

Image quality	Image size	Type of the “Memory Stick”				
		8MB (supplied)	16MB (optional)	32MB (optional)	64MB (optional)	128MB (optional)
SUPER FINE	1152 × 864	12 images	25 images	51 images	100 images	205 images
	640 × 480	40 images	80 images	160 images	325 images	650 images
FINE	1152 × 864	25 images	50 images	100 images	205 images	415 images
	640 × 480	80 images	160 images	325 images	650 images	1310 images
STANDARD	1152 × 864	37 images	74 images	150 images	300 images	600 images
	640 × 480	120 images	240 images	485 images	980 images	1970 images

### Approximate time of moving pictures you can record on a “Memory Stick”

The time of moving pictures you can record varies depending on which image size you select and the complexity of the subject.

Image size	Type of the “Memory Stick”				
	8MB (supplied)	16MB (optional)	32MB (optional)	64MB (optional)	128MB (optional)
320 × 240	1 min. 20 sec.	2 min. 40 sec.	5 min. 20 sec.	10 min. 40 sec.	21 min. 20 sec.
160 × 112	5 min. 20 sec.	10 min. 40 sec.	21 min. 20 sec.	42 min. 40 sec.	85 min. 20 sec.

The table above shows approximate number and times of still images and moving pictures you can record on a “Memory Stick” formatted by your camcorder.

#### Note

When still images recorded on your camcorder in 1152 × 864 size are played back on other equipment that does not support 1152 × 864 size, the full image may not appear, or images in the reduced size may appear in the center of the screen.

# Recording still images on a “Memory Stick” – Memory Photo recording

You can record still images on a “Memory Stick.”

## Before operation

Insert a “Memory Stick” into your camcorder.

- (1) Set the POWER switch to MEMORY/NETWORK (DCR-TRV950 only). Make sure that the LOCK switch is set to the further side (unlock position).
- (2) Press PHOTO lightly. The green ● mark stops flashing, then lights up. The brightness of the image and focus are adjusted, being targeted for the middle of the image and are fixed. Recording does not start yet.
- (3) Press PHOTO deeper.

The still image will be displayed after the shutter sounds.

Recording is complete when the bar scroll indicator disappears.

The image when you pressed PHOTO deeper will be recorded on the “Memory Stick.”

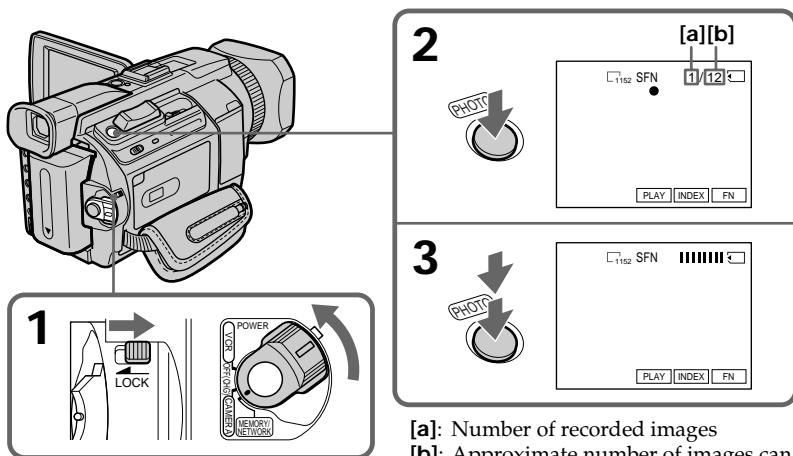

## You can record still images on a “Memory Stick” in the tape recording or recording standby

For the details, see p. 46.

## Recording still images on a "Memory Stick" - Memory Photo recording

---

### When the POWER switch is set to MEMORY/NETWORK (DCR-TRV950 only)

The following functions do not work:

- Digital zoom
- Wide mode
- Fader
- Picture effect
- Digital effect
- Sports lesson of PROGRAM AE (The indicator flashes.)
- Title

### While you are recording a still image

You can neither turn off the power nor press PHOTO.

### When you press PHOTO on the Remote Commander

Your camcorder immediately records the image that is on the screen when you press the button.

### When you press PHOTO lightly in step 2

The image momentarily flickers. This is not a malfunction.

### Recording data

The recording data (date/time or various settings when recorded) are not displayed while recording. However, they are recorded automatically onto the "Memory Stick." To display the recording data, press the DATA CODE button during playback. You can also use the Remote Commander for this operation (p. 41).

### When the POWER switch is set to MEMORY/NETWORK (DCR-TRV950 only)

The angle of view is slightly larger compared with the angle of view when the POWER switch is set to CAMERA.



# Recording still images on a “Memory Stick” - Memory Photo recording

## Recording images continuously

You can record still images continuously. Before recording, select one of the four modes described below in the menu settings.

### **NORMAL [a]**

Your camcorder shoots up to four still images in 1152 × 864 size or 13 still images in 640 × 480 size at about 0.5 sec intervals. (  )

### **EXP BRKTG (Exposure Bracketing)**

Your camcorder automatically shoots three images at about 0.5 sec intervals at different exposures. ( **BRK** )

### **MULTI SCRIN (Multi Screen) [b]**

Your camcorder shoots nine still images at about 0.4 sec intervals and displays the images on a single page divided into nine boxes. Still images are recorded in 640 × 480 size. (  )

[a]



[b]



# Recording still images on a "Memory Stick" - Memory Photo recording

- (1) Set the POWER switch to MEMORY/NETWORK (DCR-TRV950 only). Make sure that the LOCK switch is set to the further side (unlock position).
- (2) Press MENU, then select BURST while STILL SET is selected in , then press the dial (p. 211).
- (3) Turn the SEL/PUSH EXEC dial to select the desired setting, then press the dial.
- (4) Press MENU to make the menu setting disappear.
- (5) Press PHOTO deeper.

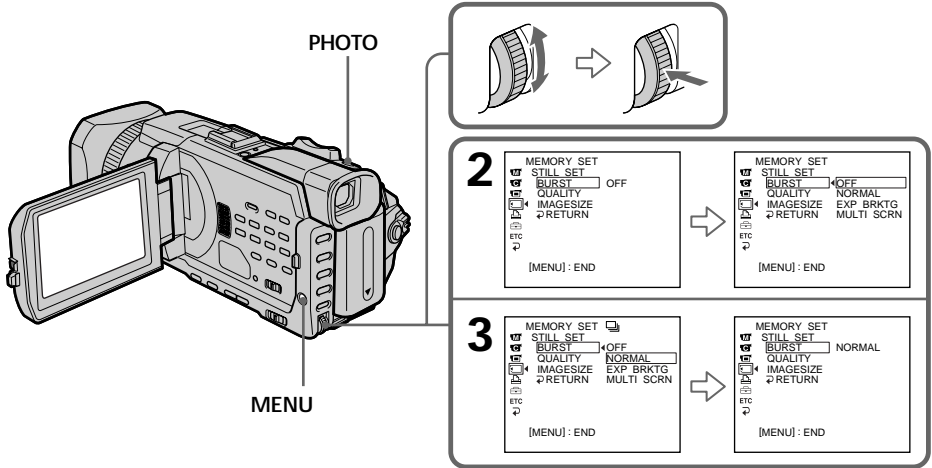

## If the capacity of the "Memory Stick" becomes full

" FULL" appears on the screen, and you cannot record a still image on this "Memory Stick."

## The number of still images in continuous shooting

The number of still images you can shoot continuously varies depending on the image size and the capacity of the "Memory Stick."

## During recording still images continuously

The flash does not work.

## The effect of exposure bracketing (EXP BRKTG)

The effect may not appear clearly on the LCD screen.

Checking images on a TV monitor or computer display for the expected effect is recommended.

## When selecting NORMAL

Recording continues up to the maximum number of still images during pressing PHOTO deeper. Release PHOTO to stop recording.

## When shooting with the self-timer or the Remote Commander

Your camcorder automatically records up to the maximum recordable number of still images.

## Recording still images on a “Memory Stick” – Memory Photo recording

If there is space remaining on the “Memory Stick” for less than three photos



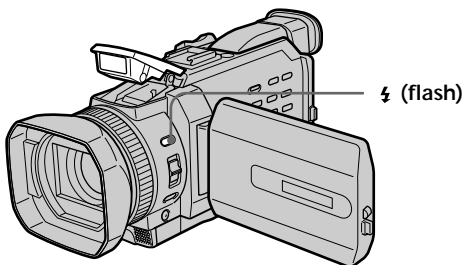

You cannot carry out the exposure bracketing (EXP BRKTG). “ FULL” is displayed when you press PHOTO.

### Recording images with the flash

The flash automatically pops up to strobe. The default setting is auto (no indicator). To change the flash mode, press  (flash) repeatedly until the flash mode indicator appears on the screen.



Each press of  (flash) changes the indicator as follows:

- →  →  → (no indicator)
- Auto red-eye reduction: The flash fires before recording to reduce the red-eye phenomenon.
-  Forced flash: The flash fires regardless of the surrounding brightness.
-  No flash: The flash does not fire.

The flash is automatically adjusted to the appropriate brightness. You can also change FLASH LVL to the desired brightness in the menu settings (p. 208). Try recording various images to find the most appropriate setting for FLASH LVL.

## Recording still images on a “Memory Stick” – Memory Photo recording

---

### Notes

- The recommended shooting distance using the built-in flash is 0.8 m to 2.5 m (2 3/5 feet to 8 1/3 feet).
- Attaching the lens hood or a conversion lens (optional) may block the light from the flash or cause lens shadow to appear.
- You cannot use an external flash (optional) and the built-in flash at the same time.
-  (auto red-eye reduction) may not produce the desired effect depending on individual differences, the distance to the subject, the subject not looking at the pre-recording flash or other conditions.
- The flash effect cannot be obtained easily when you use forced flash in a bright location.
- If it is not easy to focus on a subject automatically, for example, when recording in the dark, use HOLOGRAM AF (p. 141) or the focal distance information (p. 77) for focusing manually.

### When the flashlight does not reach to the subjects

The color of the image may change.

### If you leave your camcorder for five or more minutes after removing the power supply

Your camcorder returns to the default setting (auto).

### The flash does not fire even if you select auto and (auto red-eye reduction) during the following operations:

- Spot light
- Shutter speed adjustment
- Sunset & moon of PROGRAM AE
- Landscape of PROGRAM AE
- Exposure
- Flexible Spot meter

### When you use an external flash (optional) which does not have the auto red-eye reduction

You cannot select the auto red-eye reduction.

### During recording images continuously

The flash does not work.

## Recording still images on a “Memory Stick” - Memory Photo recording

### Shooting with an auxiliary light - HOLOGRAM AF

The HOLOGRAM AF is an auxiliary light source used for focusing on subjects in dark places.

Set HOLOGRAM F in  to AUTO in the menu settings. (The default setting is AUTO.)

When  appears on the screen in a dark place, press PHOTO lightly. Then the auxiliary light will automatically emit until the subject is focused.

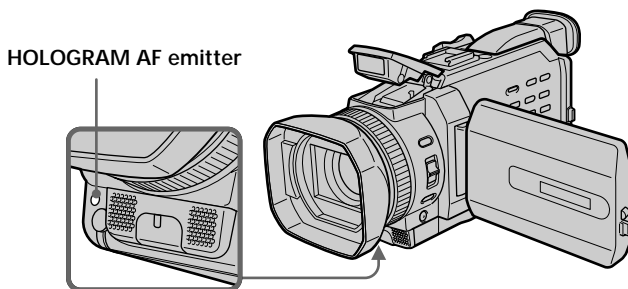

#### About HOLOGRAM AF

“HOLOGRAM AF (Auto-Focus),” an application of laser holograms, is a new AF optical system that enables still image shooting in dark places. Having gentler radiation than conventional high-brightness LEDs or lamps, the system satisfies Laser Class 1 (\*) specification and thus maintains higher safety for human eyes.

No safety problems will be caused by directly looking into the HOLOGRAM AF emitter at a close range. However, it is not recommended to do so, because you may experience such effects like several minutes of image residual and dazzling, that you encounter after looking into a flashlight.

\* HOLOGRAM AF satisfies Class 1(time base 30 000 seconds), specified in all of JIS (Japan), IEC(EU), and FDA(US) industry standards.

Complying with these standards identifies the laser product to be safe, under a condition that a human looks at the laser light either directly or even through a lens for 30 000 seconds.

# Recording still images on a “Memory Stick”

## - Memory Photo recording

---

### Notes

- Attaching the lens hood or a conversion lens (optional) may obstruct the HOLOGRAM AF light and make focusing difficult. We recommend removing the lens hood or a conversion lens while shooting with the HOLOGRAM AF.
- If enough light does not reach the subject even if the HOLOGRAM AF emitter is emitted (recommended shooting distance is 2.5 m (8 1/3 feet)), the subject will not be focused.
- Focusing may be hampered if the light emitted from the HOLOGRAM AF is blocked by an obstruction.
- Focus is achieved as long as HOLOGRAM AF light reaches to the subject even if its light is slightly out of the middle position of the subject.
- If HOLOGRAM AF light is dim, it sometimes becomes difficult to focus. If this happens, wipe the HOLOGRAM AF emitter with a soft, dry cloth.

### The HOLOGRAM AF does not emit when:

- Flash is set to  No flash
- Focus manually
- Spot Focus
- Sunset & moon of PROGRAM AE
- Landscape of PROGRAM AE
- Continuous photo recording

**When you use the external flash (optional) as well**  
HOLOGRAM AF emits.

## Recording still images on a “Memory Stick” – Memory Photo recording

### Self-timer memory photo recording

You can record images on a “Memory Stick” with the self-timer. You can also use the Remote Commander for this operation.

- (1) Set the POWER switch to MEMORY/NETWORK (DCR-TRV950 only). Make sure that the LOCK switch is set to the further side (unlock position).
- (2) Press FN to display PAGE1.
- (3) Press SELFTIMER.  
The  (self-timer) indicator appears on the screen.
- (4) Press PHOTO deeper.  
Self-timer starts counting down from 10 with a beep. In the last two seconds of the countdown, the beep gets faster, then recording starts automatically.

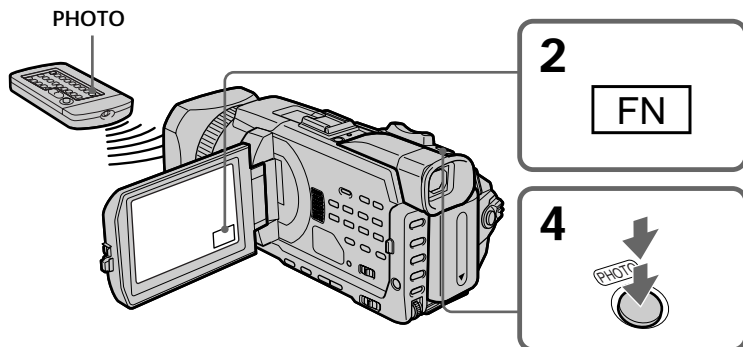

### To cancel the self-timer

Press SELFTIMER so that the  (self-timer) indicator disappears on the screen. You cannot stop the countdown.

### Note

The self-timer is automatically canceled when:

- Self-timer recording is finished.
- The POWER switch is set to OFF (CHG) or VCR.

# Recording images from a tape as still images

Your camcorder can read moving picture data recorded on a tape and record it as a still image on a "Memory Stick." Your camcorder can also capture moving picture data through the input connector and record it as a still image on a "Memory Stick."

## Before operation

Insert a "Memory Stick" and the recorded tape into your camcorder.

- (1) Set the POWER switch to VCR.
- (2) Press **▶**. Moving pictures recorded on the tape are played back.
- (3) Press PHOTO lightly until the picture you want to capture from the tape freezes and CAPTURE appears on the screen. Recording does not start yet. To change from the selected image to another image, release PHOTO once and press it lightly again.
- (4) Press PHOTO deeper. The image displayed on the screen will be recorded on the "Memory Stick." Recording is complete when the bar scroll indicator disappears.

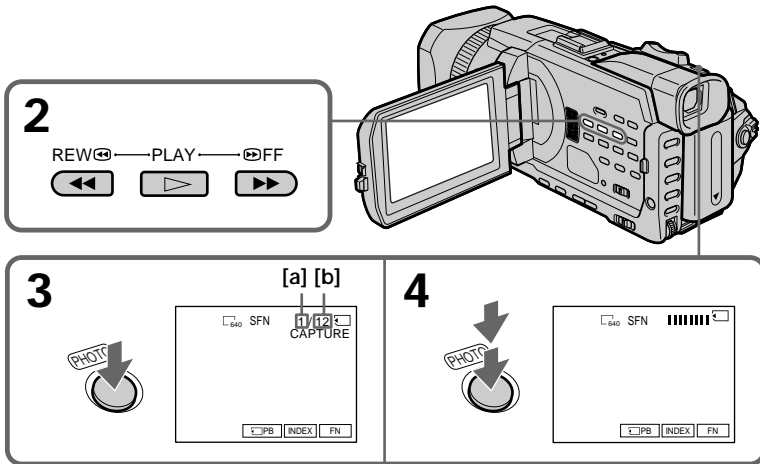

[a] : Number of the recorded images

[b] : Approximate number of the images that can be recorded on the "Memory Stick"



## Recording images from a tape as still images

---

### Image size of still images

Image size is automatically set to 640 × 480.

### When the access lamp is lit or flashing

Do not shake or strike the unit. Also, do not turn the power off, eject the "Memory Stick." Otherwise, image data may become damaged.

### If "FORMAT ERROR" appears on the screen

The inserted "Memory Stick" is incompatible with your camcorder because its format does not conform with your camcorder. Check the format of the "Memory Stick."

### If you press PHOTO lightly in the playback

Your camcorder stops momentarily.

### Sound recorded on a tape

You cannot record audio from a tape.

### Titles already recorded on cassettes

You cannot record titles on a "Memory Stick." Titles do not appear while you are recording a still image with PHOTO.

### Recording date/time

The recording data (date/time) when it is recorded on a "Memory Stick" is recorded. Various settings are not recorded.

Data codes recorded on a tape cannot be recorded on a "Memory Stick."

### When you press PHOTO on the Remote Commander

Your camcorder immediately records the image that is on the screen when you press the button.

## Recording images from a tape as still images

### Recording a still image from external equipment

#### Before operation

Set DISPLAY in **ETC** to LCD in the menu settings. (The default setting is LCD.)

- (1) Set the POWER switch to VCR.
- (2) Play back the recorded tape, or turn the TV on to see the desired program.  
The image of the external equipment is displayed on the screen.
- (3) Follow steps 3 and 4 on page 144.

#### Using the A/V connecting cable

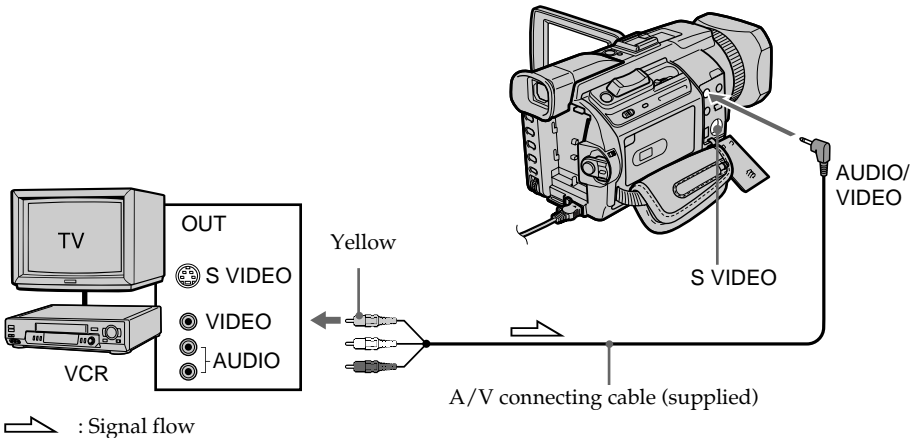

Connect the yellow plug of the A/V connecting cable to the video jack on the VCR or the TV.

#### If your TV or VCR has an S video jack

Pictures can be reproduced more faithfully by using an S video cable (optional).

With this connection, you do not need to connect the yellow (video) plug of the A/V connecting cable.

Connect an S video cable (optional) to the S video jacks of both your camcorder and the TV or VCR.

## Recording images from a tape as still images

### Using the i.LINK cable

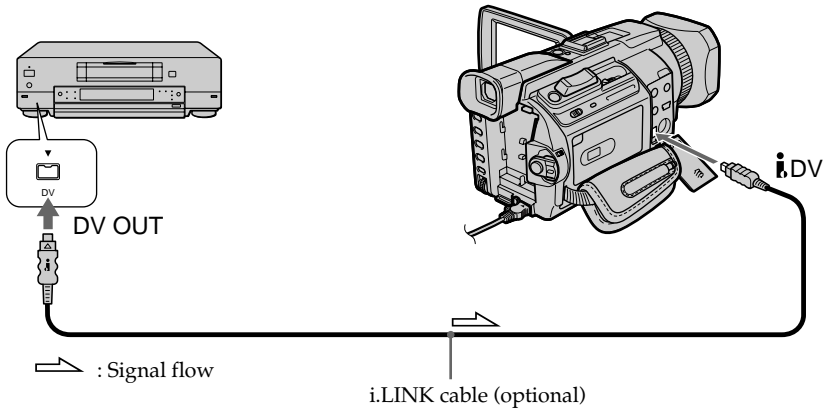

#### Note

In the following instances, recording is interrupted or "REC ERROR" is displayed, and recording is not possible. Reinsert the "Memory Stick" to record distortion-free images.

- When recording on a tape in a poor recording state, for example, on a tape that has been repeatedly used for dubbing.
- When attempting to input images that are distorted due to poor radio wave reception when a TV tuner unit is in use.

# Superimposing a still image in the “Memory Stick” on an image

## - MEMORY MIX

You can superimpose a still image you have recorded on the “Memory Stick” on the moving picture you are recording. You can record the superimposed images on a tape or a “Memory Stick.” (However, you can record only superimposed still images on the “Memory Stick.”)

### M. CHROM (memory chroma key)

You can swap a blue area of a still image such as an illustration or a frame with a moving picture.

### M. LUMI (memory luminance key)

You can swap a brighter area of a still image such as a handwritten illustration or title with a moving picture. Record a title on the “Memory Stick” before a trip or event for convenience.

### C. CHROM (camera chroma key)

You can superimpose a moving picture on a still image such as an image can be used as background. Shoot the subject against a blue background. The blue area of the moving picture will be swapped with a still image.

### M. OVERLAP\* (memory overlap)

You can make a moving picture fade in on top of a still image recorded on the “Memory Stick.”

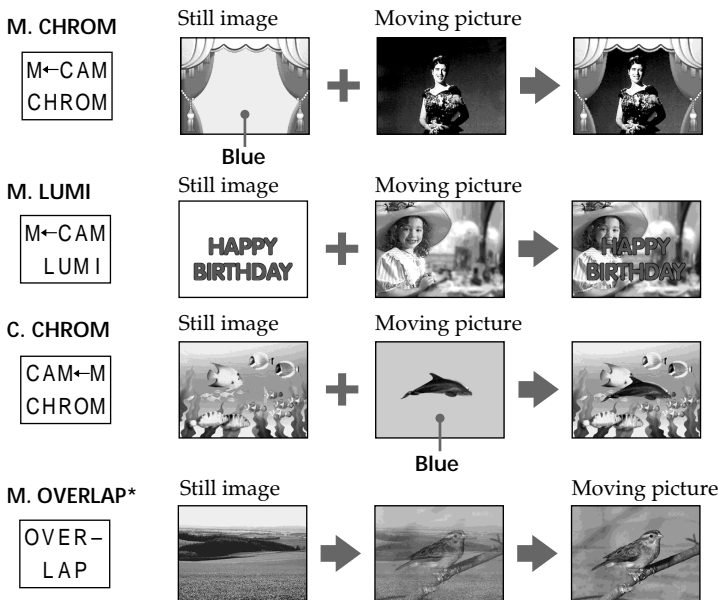

\* The superimposed image using Memory overlap can be recorded on tapes only.

## Superimposing a still image in the “Memory Stick” on an image – MEMORY MIX

### Recording superimposed images on a tape

#### Before operation

- Insert a tape for recording into your camcorder.
- Insert a “Memory Stick” recorded still images into your camcorder.

- (1) Set the POWER switch to CAMERA.
- (2) Press FN to display PAGE1.
- (3) Press MEM MIX. The last recorded or last composed image appears on the lower part of the screen as a thumbnail image.
- (4) Press -/+ on the right lower corner of the screen to select the still image which you want to superimpose.
  - : To see the previous image
  - +: To see the next image
- (5) Press a desired mode. The still image is superimposed on the moving picture.
- (6) Press -/+ on the left lower corner of the screen to adjust the effect, then press  $\Rightarrow$  OK to return to PAGE1.

- M. CHROM: Blue chroma key (only blue background portion) to extract a still image and superimpose it on a moving image
- M. LUMI: Brightness level used when extracting a still image and superimposing it on a moving image
- C. CHROM: Blue chroma key (only blue background portion) to extract a moving picture and superimpose it on a still image
- M. OVERLAP: No adjustment necessary

The fewer bars there are on the screen, the stronger the effect.

- (7) Press EXIT to return to FN.
- (8) Press START/STOP to start recording.

# Superimposing a still image in the “Memory Stick” on an image - MEMORY MIX

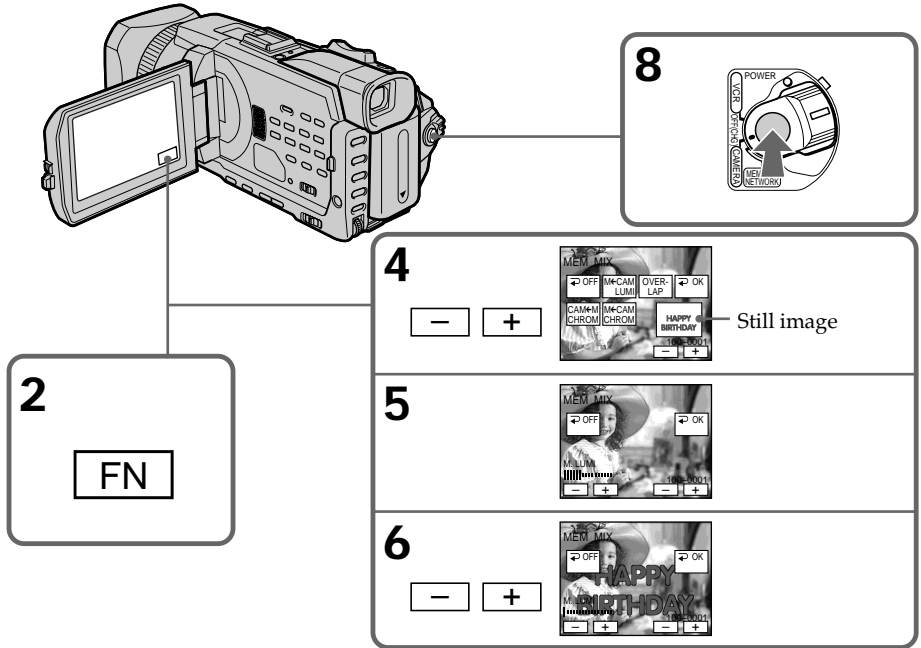

## To change the still image to be superimposed

Press -/+ on the right lower corner before step 6.

## To cancel MEMORY MIX

Press  $\leftarrow$  OFF to return to PAGE1.

## Notes

- You cannot use the MEMORY MIX for moving pictures recorded on a “Memory Stick.”
- When the overlapping still image has a large amount of white, the thumbnail image of the picture may not be clear.
- You cannot change the mode setting. Press  $\leftarrow$  OFF to return to PAGE1.

## Image data modified on your computer or shot with other equipment

You may not be able to play back modified images with your camcorder.

## When you record the still image without superimposing

Select M. LUMI. mode. Press <-/+ mark> until all bars are displayed. Only the still image will be displayed on the screen.

## When you select M. OVERLAP

You cannot change the still image or the mode setting.

## To record the superimposed image as a still image

Press PHOTO deeper in step 8 (You should set PHOTO REC in  $\left[ \text{G} \right]$  to TAPE in the menu settings beforehand).

### Recording superimposed images on a “Memory Stick” as a still image

#### Before operation

Insert a “Memory Stick” recorded still images into your camcorder.

- (1) Set the POWER switch to MEMORY/NETWORK (DCR-TRV950 only). Make sure that the LOCK switch is set to the further side (unlock position).
- (2) Press FN and select PAGE2.
- (3) Press MEM MIX. The last recorded or last composed image appears on the lower part of the screen as a thumbnail image.
- (4) Press  $-/+$  on the right lower corner of the screen to select the still image which you want to superimpose.
  - : To see the previous image
  - +: To see the next image
- (5) Press a desired mode. The still image is superimposed on the moving picture.
- (6) Press  $-/+$  on the left lower corner of the screen to adjust the effect, then press  $\Rightarrow$  OK to return to PAGE2.

- M. CHROM: Blue chroma key (only blue background portion) to extract a still image and superimpose it on a moving image
- M. LUMI: Brightness level used when extracting a still image and superimposing it on a moving image
- C. CHROM: Blue chroma key (only blue background portion) to extract a moving picture and superimpose it on a still image

The fewer bars there are on the screen, the stronger the effect.

- (7) Press EXIT to return to FN.
- (8) Press PHOTO deeper to start recording.

The image displayed on the screen will be recorded on the “Memory Stick.”  
Recording is complete when the bar scroll indicator disappears.

# Superimposing a still image in the “Memory Stick” on an image - MEMORY MIX

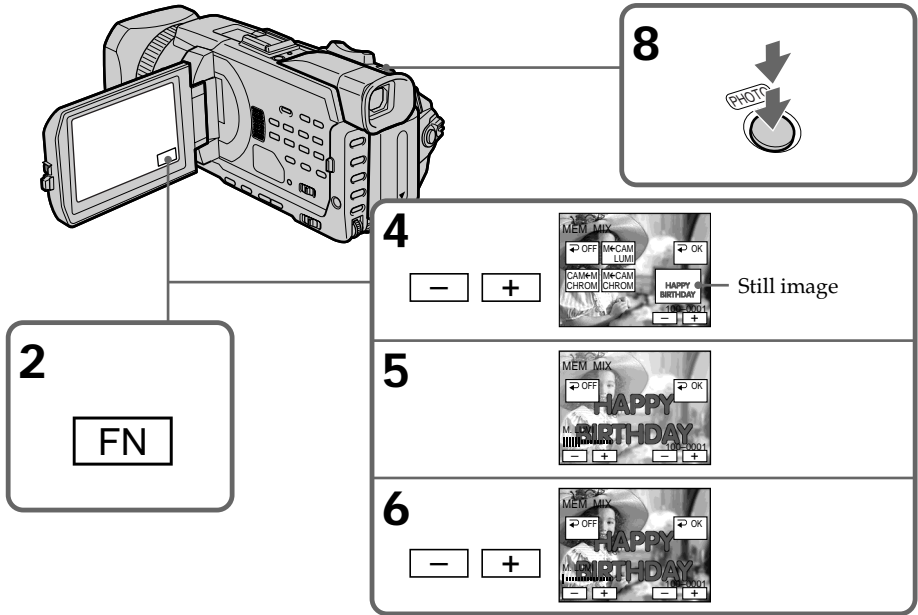

## To change the still image to be superimposed

Press -/+ on the right lower corner before step 6.

## To cancel MEMORY MIX

Press  $\rightarrow$  OFF to return to PAGE2.

### Notes

- You cannot use MEMORY MIX for moving pictures recorded on a “Memory Stick.”
- When the overlapping still image has a large amount of white, the thumbnail image of the picture may not be clear.
- You cannot change the mode setting. Press  $\rightarrow$  OFF to return to PAGE2.

### Image size of still pictures

Image size is automatically set to 640 × 480.

### Image data modified with your computers or shot with other equipment

You may not be able to play back modified images with your camcorder.

### When recording images on a “Memory Stick” using the MEMORY MIX

The PROGRAM AE does not work. (The indicator flashes.)

### The “Memory Stick” supplied with your camcorder stores 20 images

- For M. CHROM: 18 images (such as a frame) 100-0001~100-0018

- For C. CHROM: two images (such as a background) 100-0019~100-0020

### Sample images

Sample images stored in the “Memory Stick” supplied with your camcorder are protected (p. 176).



# Recording moving pictures on a “Memory Stick” – MPEG movie recording

You can record moving pictures with sound on a “Memory Stick.”

You can record picture and sound continuously up to the capacity of a “Memory Stick” (MPEG MOVIE EX).

## Before operation

Insert a “Memory Stick” into your camcorder.

- (1) Set the POWER switch to MEMORY/NETWORK (DCR-TRV950 only). Make sure that the LOCK switch is set to the further side (unlock position).
- (2) Press START/STOP. Your camcorder starts recording. The camera recording lamp located on the front of your camcorder lights up. The picture and sound are recorded up to the remaining capacity of the “Memory Stick.” For more information about recording time, see page 134.

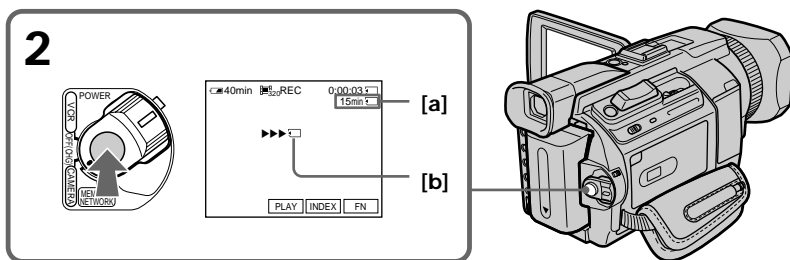

[a]: Recording time can be recorded on the “Memory Stick”.

[b]: This indicator is displayed for five seconds after pressing START/STOP. This indicator is not recorded.

## To stop recording

Press START/STOP.

## Recording moving pictures on a "Memory Stick" - MPEG movie recording

---

### Note

Sound is recorded in monaural.

### When the POWER switch is set to MEMORY/NETWORK (DCR-TRV950 only)

The following functions do not work:

- Digital zoom
- Wide mode
- Fader
- Picture effect
- Digital effect
- Sports lesson of PROGRAM AE (The indicator flashes.)
- Title

### When using an external flash (optional)

Turn the power of the external flash off when recording moving pictures on a "Memory Stick." Otherwise, the charging sound for the flash may be recorded.

### Recording date/time

The date/time are not displayed while recording. However, they are automatically recorded onto the "Memory Stick."

To display the recording date/time, press the DATA CODE button during playback. You can also use the Remote Commander for this operation (p. 41). Various settings cannot be recorded.

### During recording on a "Memory Stick"

Do not eject the cassette tape from your camcorder. During ejecting the tape, sound is recorded on the "Memory Stick."

### When the POWER switch is set to MEMORY/NETWORK (DCR-TRV950 only)

The angle of view is slightly larger compared with the angle of view when the POWER switch is set to CAMERA.

# Recording moving pictures on a “Memory Stick” – MPEG movie recording

## Self-timer MPEG movie recording

You can record images on a “Memory Stick” with the self-timer. You can also use the Remote Commander for this operation.

- (1) Set the POWER switch to MEMORY/NETWORK (DCR-TRV950 only). Make sure that the LOCK switch is set to the further side (unlock position).
- (2) Press FN to display PAGE1.
- (3) Press SELFTIMER.  
The  (self-timer) indicator appears on the screen.
- (4) Press START/STOP.  
Self-timer starts counting down from 10 with a beep. In the last two seconds of the countdown, the beep gets faster, then recording starts automatically.

START/STOP button

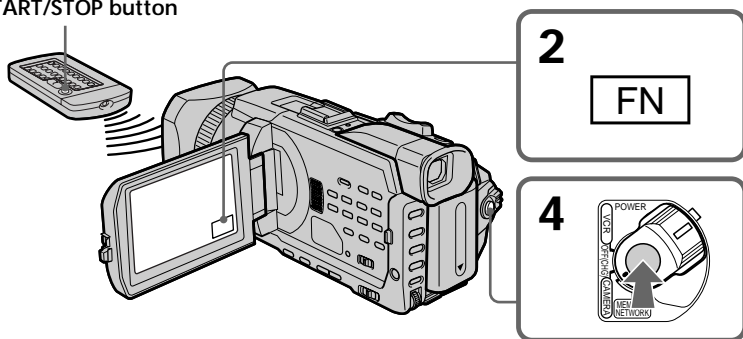

### To stop the self-timer

Press START/STOP. To restart the self-timer, press START/STOP again.

### To cancel the self-timer

Press SELFTIMER so that the  (self-timer) indicator disappears on the screen.

### Note

The self-timer is automatically canceled when:

- Self-timer recording is finished.
- The POWER switch is set to OFF (CHG) or VCR.

# Recording pictures from a tape as a moving picture

Your camcorder can read moving picture data recorded on a tape and record it as a moving picture on a “Memory Stick.” Your camcorder can also capture moving picture data through the input connector and record it as a moving picture on a “Memory Stick.”

## Before operation

Insert a “Memory Stick” and the recorded tape into your camcorder.

- (1) Set the POWER switch to VCR.
- (2) Press **▶**. The picture recorded on the tape is played back. And press **⏸** at the scene where you want to start recording from.
- (3) Press START/STOP on your camcorder. The picture and sound are recorded up to the remaining capacity of the “Memory Stick.” For more information about recording time, see page 134.

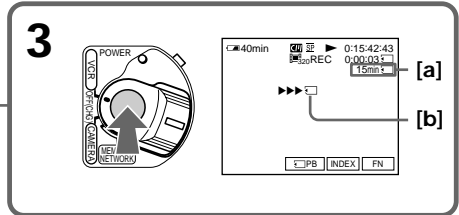
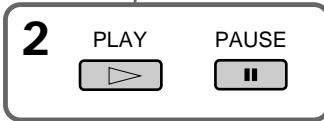
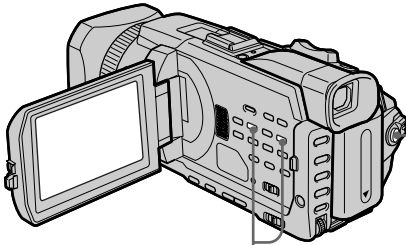

[a]: The recording time can be recorded on the “Memory Stick.”

[b]: This indicator is displayed for five seconds after pressing START/STOP. This indicator is not recorded.

## To stop recording

Press START/STOP.

## Recording pictures from a tape as a moving picture

---

### Notes

- Sound recorded in 48 kHz is converted to 32 kHz sound when recording images from a tape to a "Memory Stick."
- Sound recorded in stereo is converted to monaural sound when recording from a tape.

### When the access lamp is lit or flashing

Do not shake or knock the unit. Also, do not turn the power off, eject the "Memory Stick." Otherwise, image data may become damaged.

### Titles already recorded on cassettes

You cannot record titles on a "Memory Stick." Titles do not appear while you are recording moving picture with START/STOP.

### If "AUDIO ERROR" is displayed

Sound that cannot be recorded by your camcorder has been recorded. Connect the A/V connecting cable to input images from external equipment used to play back the image (p. 158).

### Recording date/time

The recording data (date/time) when it is recorded on a "Memory Stick" is recorded. Various settings are not recorded.  
Data codes recorded on a tape cannot be recorded on a "Memory Stick."

## Recording pictures from a tape as a moving picture

### Recording a moving picture from external equipment

#### Before operation

Set DISPLAY in **ETC** to LCD in the menu settings. (The default setting is LCD.)

- (1) Set the POWER switch to VCR.
- (2) Play back the recorded tape, or turn the TV on to see the desired program.  
The image of the other equipment is displayed on the screen.
- (3) Follow the procedure on page 156 from the step 3 onwards at the point where you want to start recording from.

#### Using the A/V connecting cable

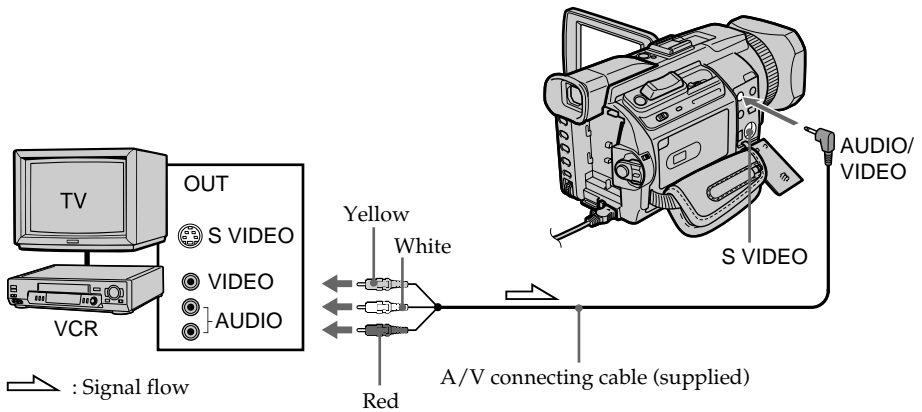

#### If your TV or VCR has an S video jack

Pictures can be reproduced more faithfully by using an S video cable (optional).

With this connection, you do not need to connect the yellow (video) plug of the A/V connecting cable.

Connect an S video cable (optional) to the S video jacks of both your camcorder and the TV or VCR.

## Recording pictures from a tape as a moving picture

### Using the i.LINK cable

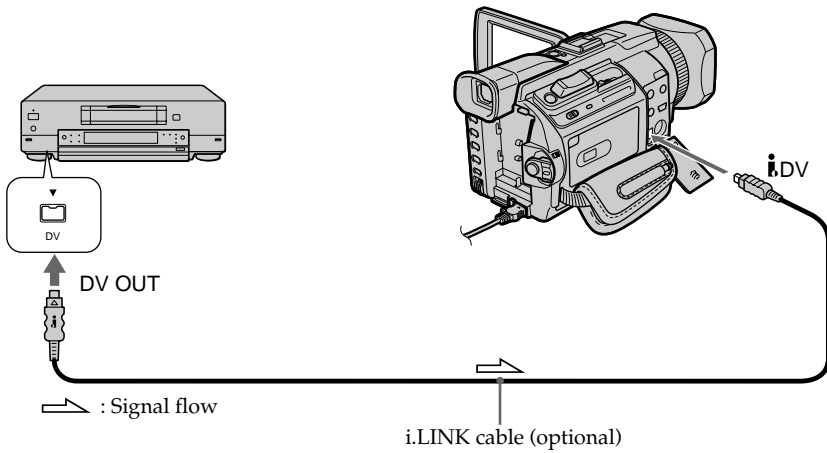

#### Note

In the following instances, "□ REC ERROR" is displayed and you cannot record pictures.

- When recording on a tape in a poor recording state, for example, on a tape that has been repeatedly used for dubbing.
- When attempting to input images that are distorted due to poor radio wave reception when a TV tuner unit is in use.
- When the input signal is cut off.

# Recording edited pictures from a tape as a moving picture – Digital program editing (on a “Memory Stick”)

You can duplicate selected scenes (programs) for editing onto a “Memory Stick.”

## Making the program

### Before operation

Insert a “Memory Stick” and a recorded tape into your camcorder.

- (1) Set the POWER switch to VCR.
- (2) Press MENU, then turn the SEL/PUSH EXEC dial to set VIDEO EDIT in [ETC] to MEMORY, then press the dial (p.217).
- (3) Turn the SEL/PUSH EXEC dial to select IMAGESIZE and select the desired image size, then press the dial.
- (4) Search for the beginning of the first scene you want to insert using the video operation buttons, then pause playback.  
You can fine-adjust one frame at a time with EDITSEARCH.
- (5) Press MARK on the Remote Commander, or turn the SEL/PUSH EXEC dial to select MARK, then press the dial.  
The IN point of the first program is set, and the top part of the program mark changes to light blue.
- (6) Search for the end of the first scene you want to insert using the video operation buttons, then pause playback.  
You can fine-adjust one frame at a time with EDITSEARCH.
- (7) Press MARK on the Remote Commander, or the SEL/PUSH EXEC dial.  
The OUT point of the first program is set, then the bottom part of the program mark changes to light blue.
- (8) Repeat steps 4 to 7, then set the program.  
When one program is set, the program mark changes to light blue.  
You can set 20 programs in maximum.

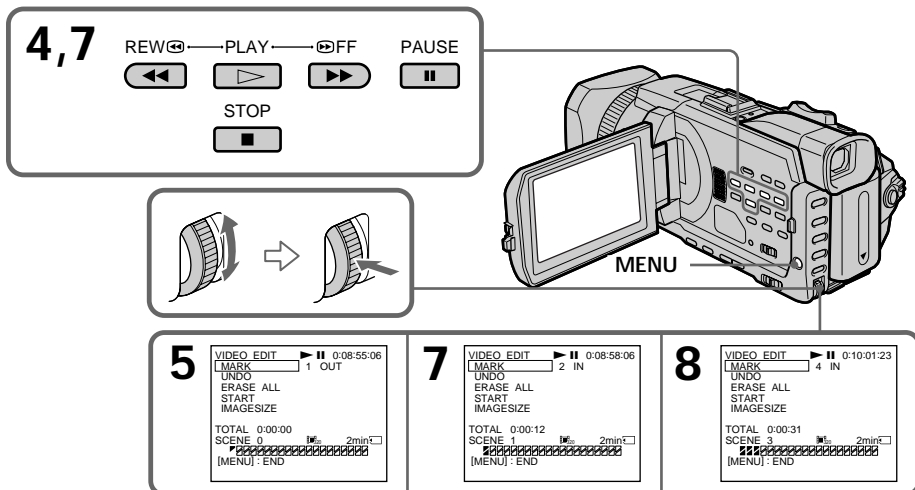



## Recording edited pictures from a tape as a moving picture - Digital program editing (on a "Memory Stick")

---

### Erasing the program you have set

Erase OUT first and then IN of the last program.

- (1) Turn the SEL/PUSH EXEC dial to select UNDO, then press the dial.
- (2) Turn the SEL/PUSH EXEC dial to select EXECUTE, then press the dial.  
The last set program mark flashes, then the setting is canceled.

### To cancel erasing

Select RETURN with the SEL/PUSH EXEC dial in step 2.

### Erasing all programs

- (1) Turn the SEL/PUSH EXEC dial to select ERASE ALL, then press the dial.
- (2) Turn the SEL/PUSH EXEC dial to select EXECUTE, then press the dial.  
All the program marks flash, then the settings are canceled.

### To cancel erasing all programs

Select RETURN with the SEL/PUSH EXEC dial in step 2.

### To cancel a program you have set

Press MENU.

The program is stored in memory until the tape is ejected.

---

### Notes

- You cannot dub the titles, display indicators, or the contents of cassette memory.
- You cannot operate recording during the digital program editing on a "Memory Stick."

### If the tape has a blank portion

You cannot set IN or OUT on the portion

### If there is a blank portion between IN and OUT on the tape

The total time code may not be displayed correctly.

### During making a program

If you eject the cassette, the program will be erased.

## Recording edited pictures from a tape as a moving picture - Digital program editing (on a "Memory Stick")

---

### Performing the program (Dubbing on a "Memory Stick")

- (1) Turn the SEL/PUSH EXEC dial to select START, then press the dial.
- (2) Turn the SEL/PUSH EXEC dial to select EXECUTE, then press the dial.  
Search for the beginning of the first program, then start dubbing.  
The program mark flashes.  
The SEARCH indicator appears during search and the EDITING indicator appears during writing of data on your camcorder, and REC appears during dubbing on the screen.  
The program mark changes to light blue after dubbing is complete.  
When the dubbing ends, your camcorder automatically stops.

#### To stop dubbing during editing

Press ■ using the video operation buttons.

The program you made is recorded on a "Memory Stick" up to the place where you pressed ■.

#### To end the Digital program editing

Your camcorder stops when the dubbing ends. Then the display returns to VIDEO EDIT in the menu settings.

Press MENU to erase the menu display.

---

#### When the program to operate the Digital program editing has not been made.

You cannot press START.

#### When the "Memory Stick" does not have enough space to record

"LOW MEMORY" appears on the screen. However, you can record pictures up to the time indicated.

#### When the "Memory Stick" has no space to record

"MEMORY FULL" appears on the screen.

#### When a "Memory Stick" is not set

"NO MEMORY STICK" appears on the screen.

#### When the write-protect switch on the "Memory Stick" is set to LOCK

"MEMORY STICK LOCKED" appears on the screen.

# Copying still images from a tape - PHOTO SAVE

Using the search function, you can automatically capture only still images from tapes and record them on a "Memory Stick" in sequence.

## Before operation

- Insert a recorded tape into your camcorder and rewind the tape.
- Insert a "Memory Stick" into your camcorder.

- (1) Set the POWER switch to VCR.
- (2) Press MENU, then turn the SEL/PUSH EXEC dial to select PHOTO SAVE in , then press the dial (p. 212).  
PHOTO BUTTON appears on the screen.
- (3) Press PHOTO deeper. The still image from the tape is recorded on the "Memory Stick." The number of still images copied is displayed. END is displayed when copying ends.

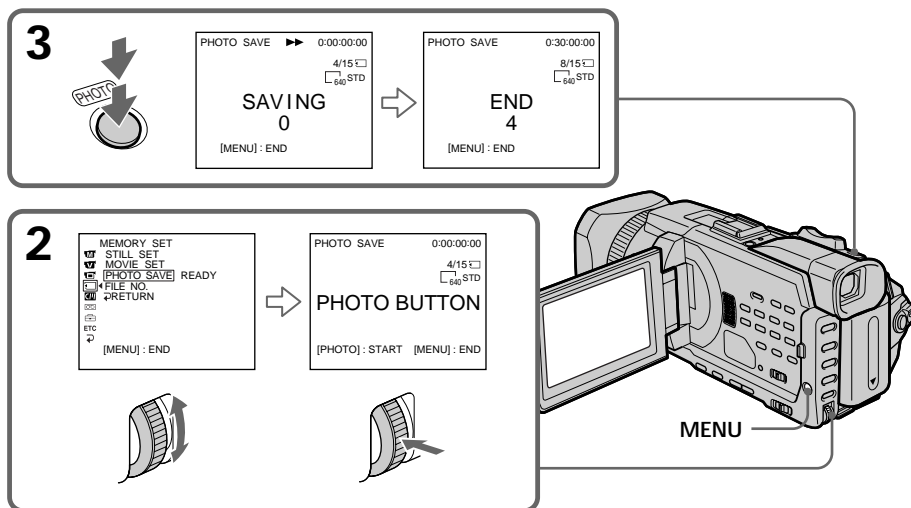

## To stop copying

Press  using the video operation buttons or press MENU.

## When the "Memory Stick" becomes full

"MEMORY FULL" appears on the screen, and copying stops. Insert another "Memory Stick" and repeat the procedure from step 2.

## Copying still images from a tape – PHOTO SAVE

---

### **Image size of still images**

Image size is automatically set to 640 × 480.

### **When the access lamp is lit or flashing**

Do not shake or knock your camcorder. As well do not turn the power off, eject the “Memory Stick.” Otherwise, image data may become damaged.

### **If the write-protect switch on the “Memory Stick” is set to LOCK**

“NOT READY” appears when you select the item in the menu settings.

### **When you change the “Memory Stick” during copying**

Your camcorder resumes copying from the last image recorded on the previous “Memory Stick.”

# Viewing still images

## - Memory photo playback

You can play back still images recorded on a "Memory Stick." You can also play back six images including moving pictures in order at a time by selecting the index screen. You can also use the Remote Commander for this operation.

### Before operation

Insert a "Memory Stick" into your camcorder.

- (1) Set the POWER switch to MEMORY/NETWORK (DCR-TRV950 only) or VCR. Make sure that the LOCK switch is set to the further side (unlock position).
- (2) Press PLAY or ◀ PB. The last recorded image is displayed.
- (3) Press -/+ on your camcorder to select the desired still image.
  - : To see the previous image
  - +: To see the next image

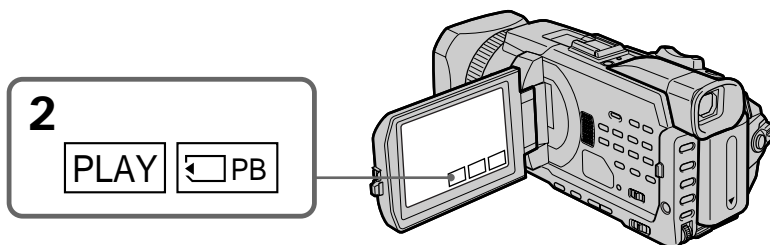

### To stop memory photo playback

Press CAM, VCR on your camcorder or MEMORY PLAY button on the Remote Commander.

## Viewing still images – Memory photo playback

You may not be able to play back images with your camcorder:

- when playing back image data modified on your computer.
- when playing back image data shot with other equipment.

### Notes on the file name

- The directory number may not be displayed and only the file name may be displayed if the structure of the directory does not conform to the DCF standard.
- “ DIRECTORY ERROR” may appear on screen if the structure of the directory does not conform to the DCF standard. While this message appears, you can play back images but cannot record them on the “Memory Stick.”
- The file name flashes on the screen if the file is corrupted or the file is unreadable.

### To play back recorded images on a TV screen

- Before operation, connect your camcorder to the TV with the A/V connecting cable supplied with your camcorder.
- When operating memory photo playback on a TV or on the LCD screen, image quality may appear to have deteriorated. This is not a malfunction. The image data is as good as ever.
- Turn the audio volume of the TV down before operation, or noise (howling) may be output from the TV speakers.

### Still images

You can select still images also with –/+ on PAGE1/PAGE2/PAGE3.

### When no still image is recorded on the “Memory Stick”

When you press MEMORY PLAY on the Remote Commander, “ NO FILE” appears.

## Screen indicators during still image playback

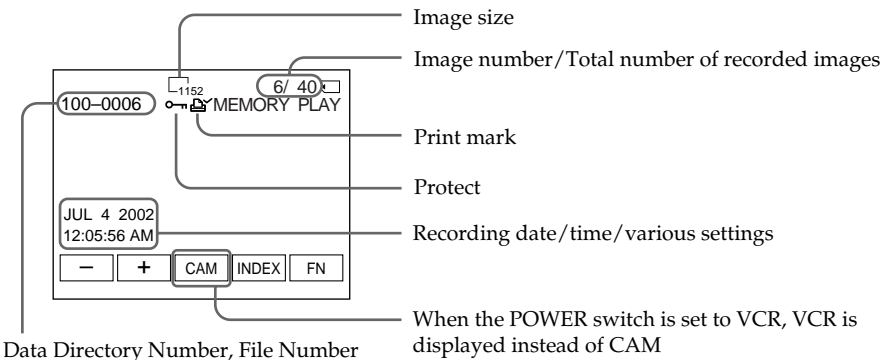

### Recording data

You can view recording data (date/time or various settings when recorded) when you press DATA CODE. You can also use the Remote Commander for this operation (p. 41).

### To make screen indicators disappear

Press DISPLAY/TOUCH PANEL.

## Viewing still images – Memory photo playback

### Playing back six recorded images at a time (index screen)

You can play back six recorded images at a time. This function is especially useful when searching for a particular image.

#### Before operation

Insert a “Memory Stick” into your camcorder.

- (1) Set the POWER switch to MEMORY/NETWORK (DCR-TRV950 only) or VCR. Make sure that the LOCK switch is set to the further side (unlock position).
- (2) Press INDEX to display the index screen.

A red ► mark appears above the image that is displayed before changing to the index screen mode.

← : To display the previous 6 images

→ : To display the following 6 images

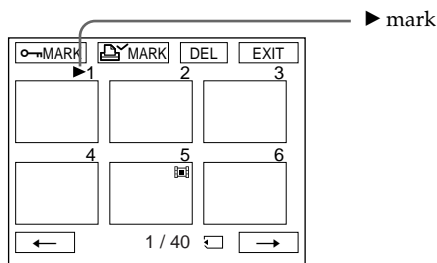

#### To return to FN

Press EXIT.

#### To return to the normal playback screen (single screen)

Press the image you want to display.

#### Note

When displaying the index screen, the number appears above each image. This indicates the order in which images are recorded on the “Memory Stick.” These numbers are different from the data file names.

#### Image data modified on your computer or shot with other equipment

These files are sometimes not displayed on the index screen.



# Viewing moving pictures

## - MPEG movie playback

You can play back moving pictures recorded on a "Memory Stick." You can also play back six images including still images in order at a time by selecting the index screen.

### Before operation

Insert a "Memory Stick" into your camcorder.

- (1) Set the POWER switch to MEMORY/NETWORK (DCR-TRV950 only) or VCR.  
Make sure that the LOCK switch is set to the further side (unlock position).
  - (2) Press PLAY or  PB. The last recorded image is displayed.
  - (3) Press +/- to select the desired moving pictures.  
- : To see the previous picture  
+ : To see the next picture
  - (4) Press MPEG   to start playback.
  - (5) To adjust the volume, press either of the two buttons on VOLUME.  
- : To turn down  
+ : To turn up
- When you close the LCD panel, sound is muted.

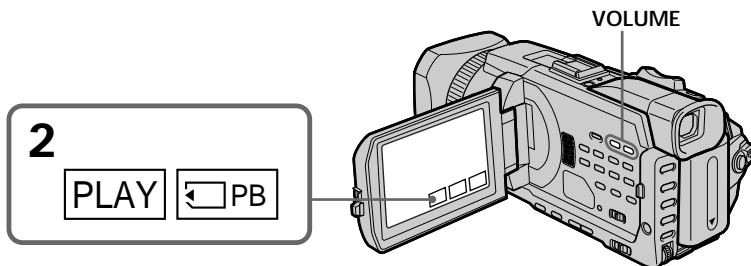

### To stop MPEG movie playback

Press MPEG  .

#### Note

You may not be able to play back images with your camcorder:

- When playing back image data modified on your computer.
- When playing back image data shot with other equipment.

#### To play back recorded images on a TV screen

- Before operation connect your camcorder to the TV with the A/V connecting cable supplied with your camcorder.
- Turn the audio volume of the TV down before operation, or noise (howling) may be output from the TV speakers.

#### Moving pictures

You can select moving pictures also with -/+ on PAGE1/PAGE2/PAGE3.

#### When no image is recorded on the "Memory Stick"

When you press MEMORY PLAY on the Remote Commander, the message " NO FILE" appears.



## Viewing moving pictures – MPEG movie playback

### Playing back a moving picture from the desired part

The moving picture recorded on a “Memory Stick” is divided into 23 parts. You can select every each one point and play back pictures.

#### Before operation

Insert a “Memory Stick” into your camcorder.

- (1) Set the POWER switch to MEMORY/NETWORK (DCR-TRV950 only) or VCR.  
Make sure that the LOCK switch is set to the further side (unlock position).
- (2) Press PLAY or  $\square$  PB. The last recorded image is displayed.
- (3) Press -/+ to select the desired moving pictures.  
- : To see the previous picture  
+ : To see the next picture
- (4) Press  $\leftarrow/\rightarrow$  to select the point where you want to play back.  
 $\leftarrow$  :To see previous part  
 $\rightarrow$  :To see next part

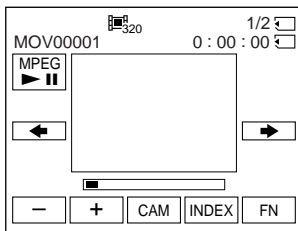

- (5) Press MPEG  $\blacktriangleright \parallel$  to start playback.

#### To stop MPEG movie playback

Press MPEG  $\blacktriangleright \parallel$

---

#### When recording time is too short

The moving picture may not be divided into 23 parts.

## Viewing moving pictures – MPEG movie playback

### Screen indicators during moving picture playback

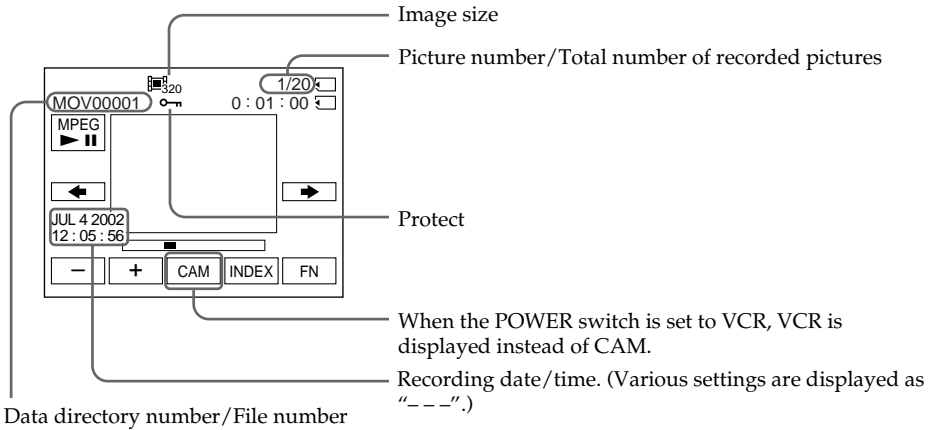

#### Recording date/time

To display the recording date/time, press DATA CODE. You can also use the Remote Commander for this operation. (p. 41)

#### To make screen indicator disappear

Press DISPLAY/TOUCH PANEL.

# Copying images recorded on a “Memory Stick” to a tape

You can copy images recorded on a “Memory Stick” and record them to a tape.

## Before operation

Insert a “Memory Stick” and a tape for recording into your camcorder.

- (1) Set the POWER switch to VCR.
- (2) Using the video control buttons, search a point where you want to record the desired images. Set the tape to playback pause.
- (3) Press ● REC and the button on its right simultaneously on your camcorder. The tape is set to the recording pause.
- (4) Press ◀ PB. The last recorded image is displayed.
- (5) Press -/+ to select the desired image.
  - : To see the previous image
  - + : To see the next image
- (6) Press || to start recording and press || again to stop.
  - appears on the screen during recording.
- (7) If you have more to copy, repeat steps 5 and 6.

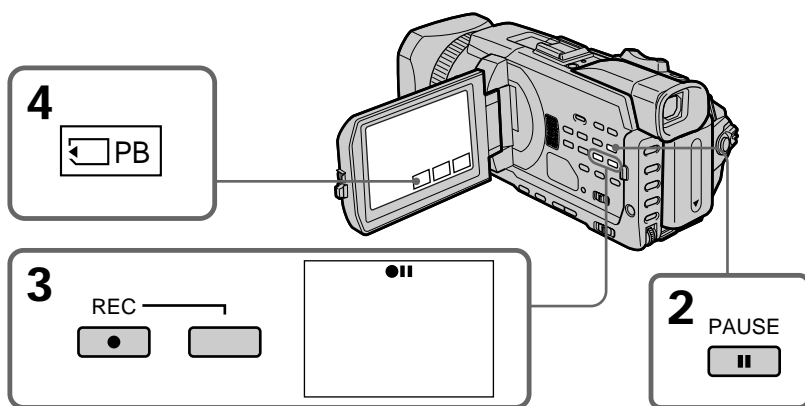

## To stop copying in the middle

Press ■.

## Copying images recorded on a “Memory Stick” to a tape

---

### **During copying**

You cannot operate the following functions:

- MEMORY PLAY
- MEMORY INDEX
- MEMORY DELETE
- MEMORY +/-

### **Note on the index screen**

You cannot record the index screen.

### **If you press EDITSEARCH during pause**

Memory playback stops.

### **Image data modified on your computers or shot with other equipment**

You may not be able to copy modified images with your camcorder.

### **When copying movies**

After step 6, press MPEG ►|| and play back the image.

# Enlarging still images recorded on a "Memory Stick" – Memory PB ZOOM

You can enlarge still images recorded on a "Memory Stick." You can select and view a desired part from the enlarged still image. Also, you can copy the desired part of the enlarged still image to tapes or a "Memory Stick".

## Before operation

Insert a "Memory Stick" into your camcorder.

- (1) Set the POWER switch to MEMORY/NETWORK (DCR-TRV950 only). Press FN to display PAGE1 during the memory playback. When you set the POWER switch to VCR, press FN and select PAGE2 during the memory playback.
- (2) Press PB ZOOM. PB ZOOM screen appears.
- (3) Press the area that you want to enlarge in the frame on the PB ZOOM screen. The area you pressed moves to the center of the screen, and the playback image is enlarged approximately at twice the size. If you press the other area, the area moves to the center of the screen.
- (4) Adjust the zoom ratio by the power zoom lever.  
You can enlarge the image from approximately 1.1 times up to five times its size.  
W : Decreases the zoom ratio.  
T : Increases the zoom ratio.

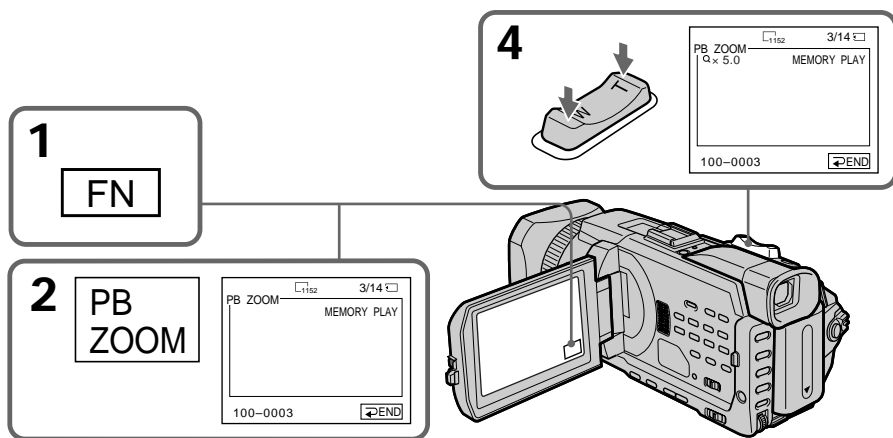

## To cancel PB ZOOM

Press  END.

## **Enlarging still images recorded on a “Memory Stick” - Memory PB ZOOM**

---

The PB ZOOM is canceled when executing the following operations:

- MENU
- MEMORY PLAY\*
- MEMORY INDEX\*
- MEMORY +/-\*

\* When these functions are selected by the Remote Commander.

### **Moving pictures recorded on a “Memory Stick”**

The PB ZOOM does not work.

### **To record the still image processed by Memory PB ZOOM on a “Memory Stick”**

Press PHOTO to record the still image processed by PB ZOOM. (Images are recorded at 640 × 480 size.)

### **In the PB ZOOM mode**

If you press DISPLAY/TOUCH PANEL button, the frame on the PB ZOOM screen disappears. You cannot move the part you pressed to the center of the screen.

### **Edge of the enlarged image**

The edge of the enlarged image cannot be displayed at the center of the screen.

### **To record an image processed on PB ZOOM on tapes**

Follow the procedure on page 171 and execute the PB ZOOM after step 5.

# Playing back images in a continuous loop – SLIDE SHOW

You can automatically play back images in sequence. This function is useful especially when checking recorded images or during a presentation.

## Before operation

Insert a “Memory Stick” into your camcorder.

- (1) Set the POWER switch to MEMORY/NETWORK (DCR-TRV950 only). Make sure that the LOCK switch is set to the further side (unlock position).
- (2) Press FN and select PAGE3.
- (3) Press SLIDE SHOW.
- (4) Press START. Your camcorder plays back the images recorded on the “Memory Stick” in sequence.

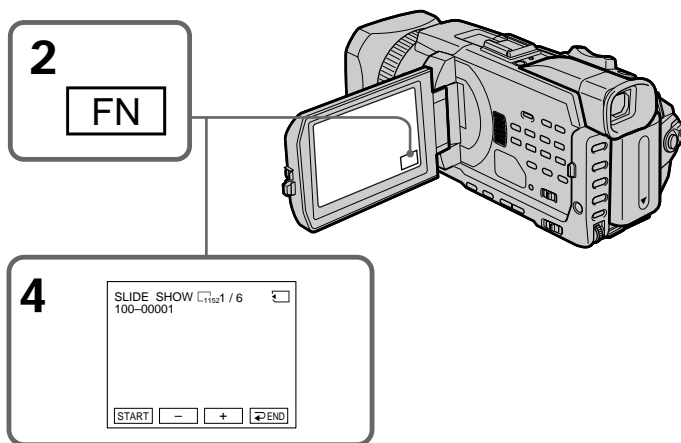

## To stop the slide show

Press END.

## To pause during a slide show

Press PAUSE.

## To return to FN

Press END to return to PAGE3, then press EXIT.

## To start the slide show from a particular image

Select the desired image using -/+ buttons before step 4.

---

## To view recorded images on TV

Before operation connect your camcorder to a TV with the A/V connecting cable supplied with your camcorder.

## If you change the “Memory Stick” during operation



The slide show does not operate. If you change the “Memory Stick,” be sure to follow the steps again from the beginning.

# Preventing accidental erasure – Image protection

You can protect selected images to prevent accidental erasure of important images.

## Before operation

Insert a “Memory Stick” into your camcorder.

- (1) Set the POWER switch to MEMORY/NETWORK (DCR-TRV950 only) or VCR.  
Make sure that the LOCK switch is set to the further side (unlock position).
- (2) Press INDEX on your camcorder to display the index.
- (3) Press  MARK. The screen to protect the image appears.
- (4) Press the image you want to protect. A “” appears on the protected image.

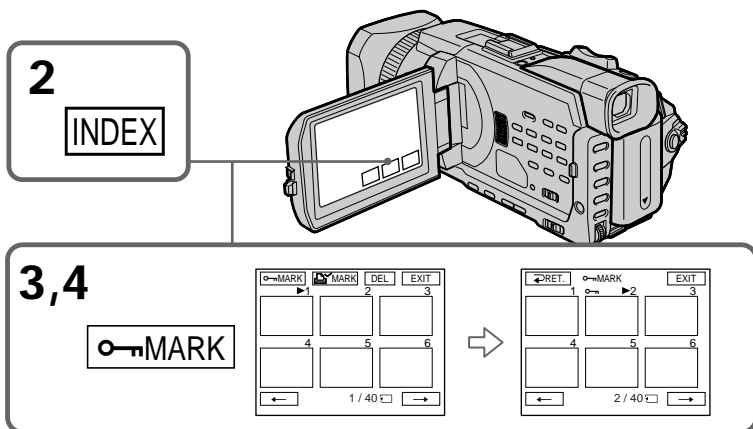

## To return to FN

Press EXIT.

## To cancel image protection

Press the image you want to cancel image protection in step 4 again. The “” disappears.

## Note

Formatting erases all information on the “Memory Stick,” including the protected image data. Before formatting a “Memory Stick,” check its contents.

**If the write-protect switch on the “Memory Stick” is set to LOCK**

You cannot protect images.



# Deleting images – DELETE

You can delete images stored in a “Memory Stick.” You can delete all images or only selected images.

## Deleting selected images

### Before operation

Insert a “Memory Stick” into your camcorder.

- (1) Set the POWER switch to MEMORY/NETWORK (DCR-TRV950 only) or VCR. Make sure that the LOCK switch is set to the further side (unlock position).
- (2) Play back the image you want to delete.
- (3) Press FN to display PAGE1.
- (4) Press DELETE. “DELETE?” appears on the LCD screen.
- (5) Press OK. The selected image is deleted.

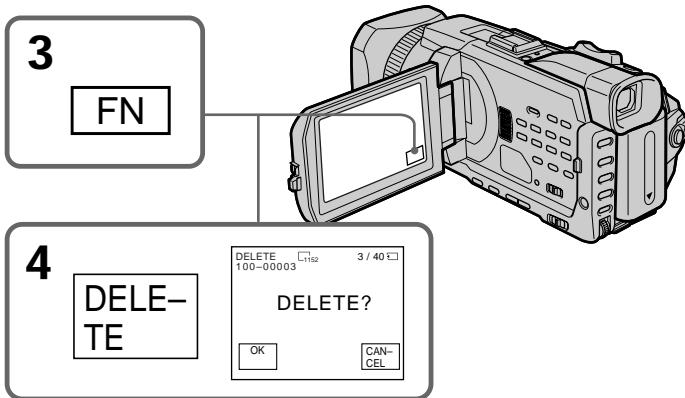

### To return to FN

Press EXIT.

### To cancel deleting an image

Press CANCEL in step 5.

### Notes

- To delete a protected image, first cancel image protection.
- Once you delete an image, you cannot restore it. Before deleting an image, carefully check the image.

### If the write-protect switch on the “Memory Stick” is set to LOCK

You cannot delete images.

## Deleting images – DELETE

### Deleting selected images on the index screen

#### Before operation

Insert a “Memory Stick” into your camcorder.

- (1) Set the POWER switch to MEMORY/NETWORK (DCR-TRV950 only). Make sure that the LOCK switch is set to the further side (unlock position).
- (2) Press INDEX to display the index screen.
- (3) Press DEL. Then press the images you want to delete. The number of the selected image is highlighted.
- (4) Press EXEC. “DELETE?” appears on the LCD screen.
- (5) Press OK. The selected images are deleted.

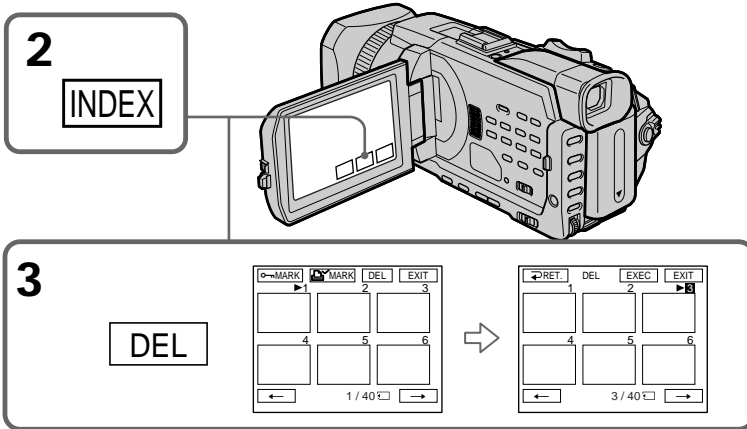

#### To return to FN

Press EXIT.

#### To cancel deleting an image

Press CANCEL in step 5.

# Deleting images - DELETE

## Deleting all images

You can delete all unprotected images in the “Memory Stick.”

### Before operation

Insert a “Memory Stick” into your camcorder.

- (1) Set the POWER switch to MEMORY/NETWORK (DCR-TRV950 only). Make sure that the LOCK switch is set to the further side (unlock position).
- (2) Press MENU, then turn the SEL/PUSH EXEC dial to select DELETE ALL in , then press the dial (p. 212).
- (3) Turn the SEL/PUSH EXEC dial to select OK, then press the dial. OK changes to EXECUTE.
- (4) Turn the SEL/PUSH EXEC dial to select EXECUTE, then press the dial. DELETING flashes on the screen. When all unprotected images are deleted, COMPLETE is displayed.

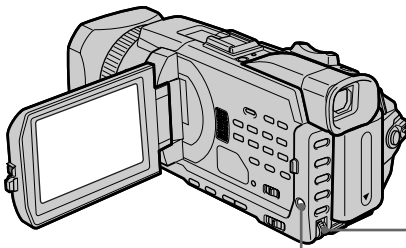

MENU

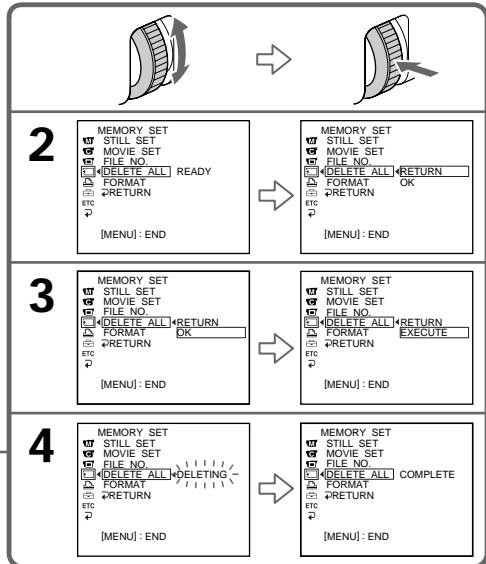

“Memory Stick” Operations

### To cancel deleting all the images in the “Memory Stick”

Select RETURN in step 3 or 4.

### While DELETING appears

Do not turn the POWER switch or press any buttons.



# Writing a print mark – PRINT MARK

You can specify a recorded still image to print out by writing a print mark. This function is useful for printing out still images later.

Your camcorder conforms to the DPOF (Digital Print Order Format) standard for specifying still images to print out.

## Before operation

Insert a "Memory Stick" into your camcorder.

- (1) Set the POWER switch to MEMORY / NETWORK (DCR-TRV950 only) or VCR.  
Make sure that the LOCK switch is set to the further side (unlock position).
- (2) Press INDEX to display the index screen.
- (3) Press  MARK. The screen used to write a print mark appears.
- (4) Press the image for which you want to write a print mark. A "" appears on the selected image.

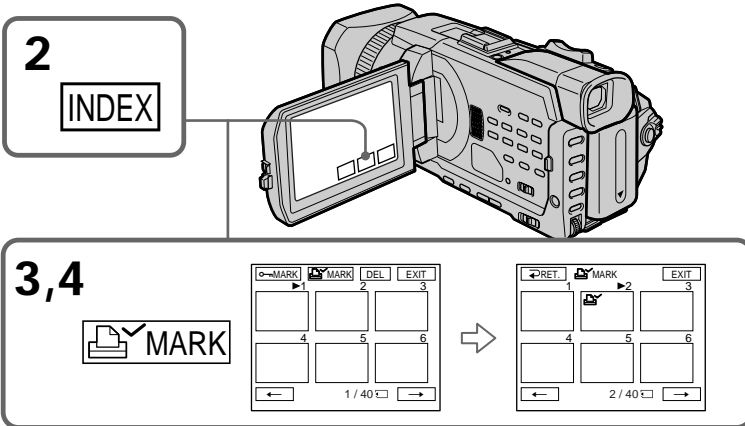

## To return to FN

Press EXIT.

## To cancel writing print marks

Press the image for which you want to cancel the print mark set in step 4 again. The  disappears.

---

## If the write-protect switch on the "Memory Stick" is set to LOCK

You cannot write print marks on still images.

## Moving pictures

You cannot write print marks on moving pictures.

# Using the optional printer

You can use the optional printer on your camcorder to print images on print paper. For details, refer to the operating instructions of the printer. There are various ways of printing still images. The following describes the setup for printing with the DATE/DAY & TIME information superimposed and the print setup required to select 9PIC PRINT.

## Before operation

- Insert a recorded "Memory Stick" into your camcorder.
- Attach the optional printer to your camcorder as illustrated.

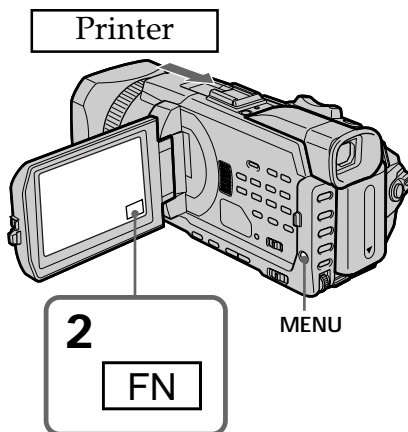

## Inserting DATE/DAY & TIME

You can print the recorded DATE/DAY & TIME data on the print paper.

- (1) Set the POWER switch to MEMORY/NETWORK (DCR-TRV950 only). Make sure that the LOCK switch is set to the further side (unlock position).
- (2) Press MENU, then turn the SEL/PUSH EXEC dial to select DATE/TIME in , then press the dial (p. 213).
- (3) Turn the SEL/PUSH EXEC dial to select the desired mode.

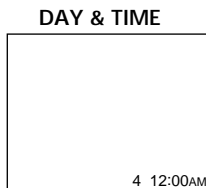
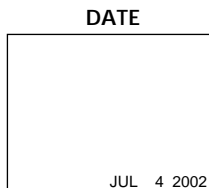

## Using the optional printer

### Selecting 9PIC PRINT

You can make 9 stickers on a single sheet when you print images recorded on a "Memory Stick" in 9PIC PRINT.

- (1) Set the POWER switch to MEMORY/NETWORK (DCR-TRV950 only). Make sure that the LOCK switch is set to the further side (unlock position).
- (2) Press FN and select PAGE3.
- (3) Press 9PIC PRINT.
- (4) Press the desired mode.

#### SAME PICS

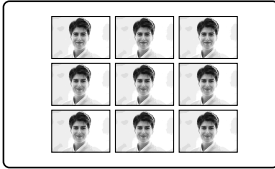

#### MULTI PICS or MARKED PICS\*



\* Nine still images with print marks are printed together.

---

#### Moving pictures recorded on a "Memory Stick"

You cannot print moving pictures. When there are no files other than moving pictures, "NO STILL IMAGE FILE" appears on the screen.

#### When the "Memory Stick" has no files

"NO FILE" appears on the screen.

#### When there are no files with a PRINT MARK

"NO PRINT MARK" appears on the screen.

#### Images processed by 9PIC PRINT

You cannot insert a DATE/TIME indicator.

#### Images recorded in the MULTI SCRN

You can print images recorded in the multi screen mode on sticker type print paper. However, each frame cannot be properly adjusted to the frames on the print paper.

# Viewing images on your computer

## - Introduction

There are the following ways of connecting the camcorder to a computer in order to view images saved on the “Memory Stick” or recorded on the tape on your computer.

To view images on a computer which has a “Memory Stick” slot, first remove the “Memory Stick” from the camcorder and then insert it into the computer’s “Memory Stick” slot.

	Camcorder Connection jack	Connection cable	Computer environment requirements
Tape stills and movies	USB jack	USB cable (supplied)	USB connector, editing software
	i.LINK (DV Interface)	i.LINK cable (optional)	DV connector, editing software
“Memory Stick” stills and movies	USB jack	USB cable (supplied)	USB connector, editing software

**When connecting to a computer via the USB jack, complete installation of the USB driver before connecting the camcorder to the computer. If you connect the camcorder to the computer first, you will not be able to install the USB driver correctly.**

For details about your computer’s connectors and editing software, contact the computer manufacturer.

### Viewing images recorded on a tape

#### When connecting to a computer using the USB jack

For more information, see page 186.

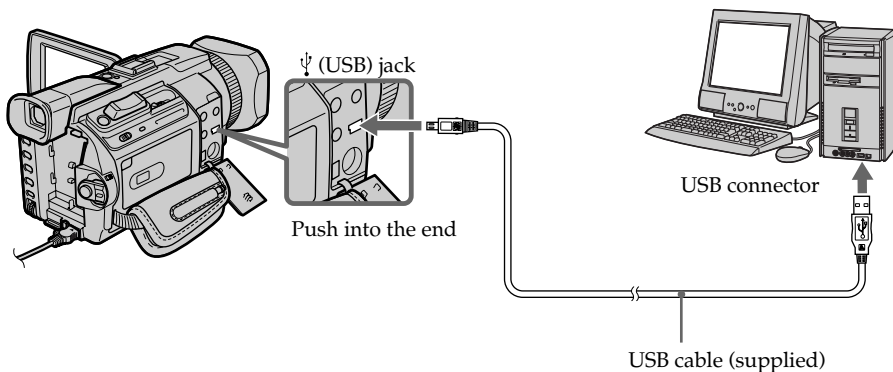

## Viewing images on your computer – Introduction

### When connecting to a computer using the i.LINK (DV interface)

Your computer must have a DV connector and editing software installed that can read video signals.

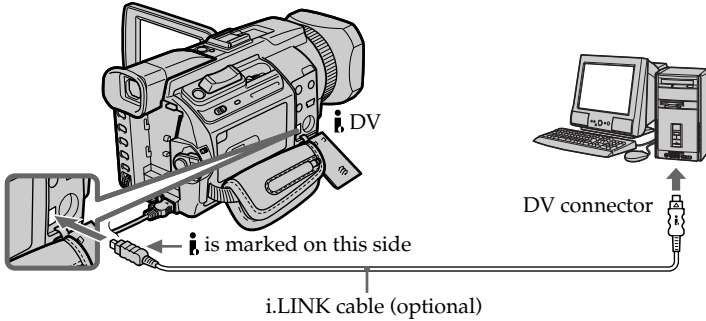

## Viewing images recorded on a "Memory Stick"

### When connecting to a computer using the USB jack

There are two methods of USB connection, NORMAL and PTP. The default setting is NORMAL. Here we explain how to use the camcorder with a standard USB connection (NORMAL).

See page 186 when using Windows and page 201 when using Macintosh.

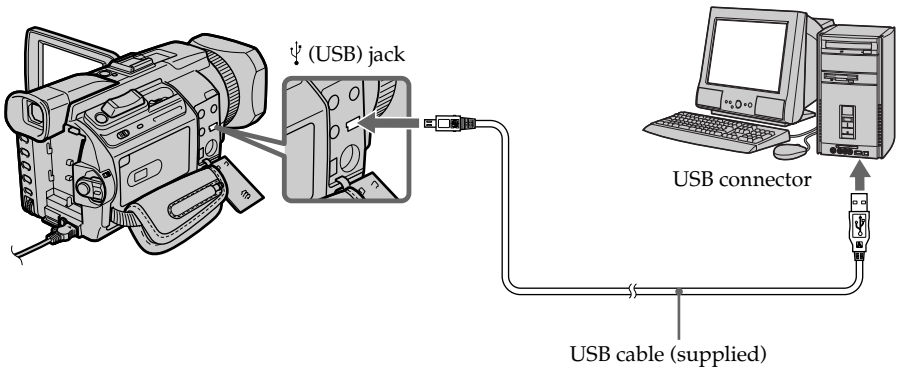

You can also use a Memory Stick Reader/Writer (optional).

### When connecting to a computer without a USB jack

Use an optional floppy disk adaptor for a Memory Stick or a PC card adaptor for a Memory Stick.

When purchasing an accessory, check its catalog beforehand for the recommended operating environment.



### Notes on using your computer

#### **“Memory Stick”**

- “Memory Stick” operations on your camcorder cannot be assured if a “Memory Stick” formatted on your computer is used on your camcorder, or if the “Memory Stick” in your camcorder was formatted from your computer when the USB cable was connected.
- Do not compress the data on the “Memory Stick.” Compressed files cannot be played back on your camcorder.

#### **Software**

- Depending on your application software, the file size may increase when you open a still image file.
- When you load an image modified using retouching software from your computer to your camcorder or when you directly modify the image on your camcorder, the image format will differ so a file error indicator may appear and you may be unable to open the file.

#### **Communications with your computer**

Communications between your camcorder and your computer may not recover after recovering from Suspend, Resume, or Sleep.

# Connecting your camcorder to your computer using the USB cable – For Windows users

Complete installation of the USB driver before connecting the camcorder to the computer. If you connect the camcorder to the computer first, you will not be able to install the USB driver correctly.

## When connecting to a computer using the USB cable

You must install a USB driver onto your computer in order to connect the camcorder to the computer's USB connector. The USB driver can be found on the CD-ROM supplied, along with the application software required for viewing images.

If you connect your camcorder and your computer using the USB cable, you can view pictures live from your camcorder and pictures recorded on a tape on your computer (USB streaming function).

Furthermore, if you download pictures from your camcorder to your computer, you can process or edit them in image processing software and append them to e-mail. You can view images recorded on the "Memory Stick" on your computer.

## Recommended computer usage environment when connecting via USB cable and viewing tape images on the computer

### OS:

Microsoft Windows 98SE, Windows Me, Windows 2000 Professional, Windows XP Home Edition or Windows XP Professional

Standard installation is required.

However, operation is not assured if the above environment is an upgraded OS.

You cannot hear sound if your computer is running Windows 98, but you can read still images.

### CPU:

Minimum 500 MHz Intel Pentium III or faster (800 MHz or faster recommended)

### Application:

DirectX 8.0a or later

### Sound system:

16 bit stereo sound card and speakers

### Memory:

64 MB or more

### Hard disk:

Available memory required for installation:

at least 200MB

Available hard disc memory recommended:

at least 1GB (depending on the size of the image files edited)

### Display:

4 MB VRAM video card, Minimum 800 × 600 dot Hi color (16 bit color, 65,000 colors), Direct Draw display driver capability (At 800 × 600 dot or less, 256 colors and less, this product will not operate correctly.)

### Others:

This product is compatible with DirectX technology, so it is necessary to install DirectX.

The USB connector must be provided as standard.

You cannot use this function in the Macintosh environment.

## Connecting your camcorder to your computer using the USB cable – For Windows users

---

### Recommended computer usage environment when connecting via USB cable and viewing “Memory Stick” images on the computer

**OS:**

Microsoft Windows 98, Windows 98SE, Windows Me, Windows 2000 Professional, Windows XP Home Edition or Windows XP Professional  
Standard installation is required.

However, operation is not assured if the above environment is an upgraded OS.

**CPU:**

MMX Pentium 200 MHz or faster

The USB connector must be provided as standard.

Windows Media Player must be installed (to play back moving pictures).

---

**Notes**

- Operations are not guaranteed for the Windows environment if you connect two or more USB equipment to a single computer at the same time, or when using a hub.
- Some equipment may not operate depending on the type of USB equipment that is used simultaneously.
- Operations are not guaranteed for all the recommended computer environments mentioned above.
- Windows and Windows Media are trademarks or registered trademarks of Microsoft Corporation in the United States and/or other countries.
- Pentium is trademark or registered trademark of Intel Corporation.
- All other product names mentioned herein may be the trademarks or registered trademarks of their respective companies. Furthermore, “TM” and “®” are not mentioned in each case in this manual.

# Connecting your camcorder to your computer using the USB cable – For Windows users

## Installing the USB driver

Start the following operation without connecting the USB cable to your computer.  
Connect the USB cable according to “Making the computer recognize the camcorder.”

If you are using Windows 2000 Professional or Windows XP Home Edition/Professional, log in with permission of Administrators.

- (1) Turn on your computer and allow Windows to load.
- (2) Insert the supplied CD-ROM into the CD-ROM drive of your computer. The application software starts up and the title screen appears.
- (3) Move the cursor to “USB Driver” and click. This starts USB driver installation.



- (4) Follow the on-screen messages to install the USB driver.
- (5) Remove the CD-ROM and then restart the computer, in accordance with the instructions on the screen.

### Note

If you connect the USB cable before USB driver installation is complete, the USB driver will not be properly registered. Carry out installation again in accordance with the steps on page 191.

### Windows XP Home Edition/Professional users

If you go to “USB CONNECT” in the menu settings and select “PTP,” you can copy “Memory Stick” images from the camcorder onto your computer without installing the USB driver. This is ideal for simply copying images from a camcorder onto a computer. Refer to page 215 for details.

## Making the computer recognize the camcorder

### Viewing images recorded on a tape

Refer to page 190 for details on viewing "Memory Stick" images on your computer.

You need to install "PIXELA ImageMixer" to view images recorded on a tape on your computer. Install it from the CD-ROM supplied with your camcorder.

To install and use this software in Windows 2000 Professional. You must be authorized as Power Users or Administrators. For Windows XP Home Edition/Professional, you must be authorized as Administrators.

- (1) Turn on your computer and allow Windows to load.  
If you are using your computer, close all running applications.
- (2) Insert the supplied CD-ROM into the CD-ROM drive of your computer.  
The application software starts up and the title screen appears. If the title screen does not appear, double-click "My Computer" and then "ImageMixer" (CD-ROM Drive). The application software screen appears after a while.
- (3) Move the cursor to "PIXELA ImageMixer" and click.  
The Install Wizard program starts up and the "Select Settings Language" screen appears.
- (4) Select the language for installation.
- (5) Follow the on-screen messages.  
The installation screen disappears when installation is complete.
- (6) Click DirectX  
Follow the on-screen messages to install DirectX.  
Restart your computer when the installation is completed.
- (7) Connect the AC power adaptor to your camcorder.
- (8) Set the POWER switch to VCR.
- (9) Select USB STREAM in  to ON in the menu settings (p. 215).
- (10) With the CD-ROM inserted, connect the USB jacks of the camcorder and computer using the USB cable supplied with your camcorder.  
Your computer recognizes the camcorder, and the Add Hardware Wizard starts.

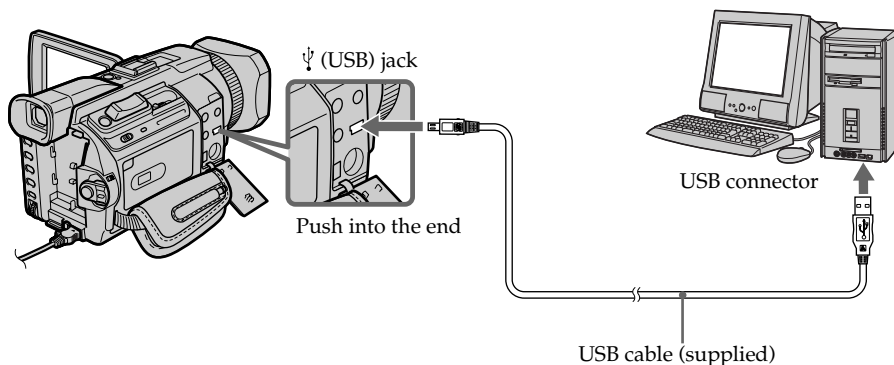

## Connecting your camcorder to your computer using the USB cable - For Windows users

---

- (11) Follow the on-screen messages so that the Add Hardware Wizard recognizes that the USB drivers have been installed. The Add Hardware Wizard starts three times because three different USB drivers are installed. Be sure to allow the installation to complete without interrupting it.

For Windows 2000 Professional, Windows XP Home Edition/Professional users

- (12) After the "File Needed" screen appears.  
Open "Browse..." → "My Computer" → "ImageMixer" → "Sonyhcb.sys",  
and click "OK."

### Viewing images recorded on a "Memory Stick"

Set USBCONNECT in  to NORMAL in the menu settings. (The default setting is set to NORMAL.)

- (1) Insert a "Memory Stick" into your camcorder.
- (2) Connect the AC power adaptor and set the POWER switch to MEMORY/  
NETWORK (DCR-TRV950 only).
- (3) Connect the  (USB) jack on your camcorder to the USB connector on your computer using the supplied USB cable.  
USB MODE appears on the LCD screen of your camcorder. Your computer recognizes the camcorder, and the Add Hardware Wizard starts.

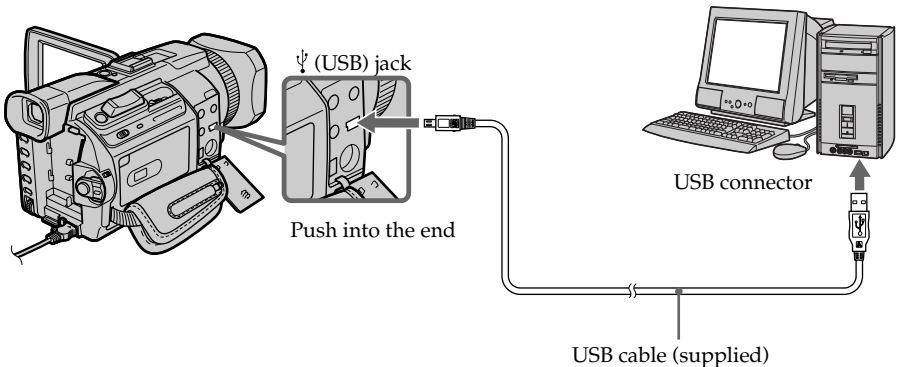

- (4) Follow the on-screen messages to make the Add Hardware Wizard recognize that the USB drivers have been installed. The Add Hardware Wizard starts two times because two different USB drivers are installed. Be sure to allow each installation to complete without interrupting it.

---

**You cannot install the USB driver if a "Memory Stick" is not in your camcorder.**  
Be sure to insert a "Memory Stick" into your camcorder before installing the USB driver.

### If you cannot install the USB driver

The USB driver has been registered incorrectly as your computer was connected to your camcorder before installation of the USB driver was completed. Perform the following procedure to correctly install the USB driver.

#### Viewing images recorded on a tape

##### Step 1: Uninstall the incorrect USB driver

- ① Turn on your computer and allow Windows to load.
- ② Connect the AC power adaptor, and set the POWER switch to VCR.
- ③ Connect the USB connector on your computer to the  $\Psi$  (USB) jack on your camcorder using the USB cable supplied with your camcorder.
- ④ Open your computer's "Device Manager."

##### **Windows XP Home Edition/Professional:**

Select "Start" → "Control Panel" → "System" → "Hardware," and click the "Device manager" button.

If there is no "System" inside "Pick a category" after clicking "Control Panel," click "Switch to classic view" instead.

##### **Windows 2000 Professional:**

Select "My Computer" → "Control Panel" → "System" → "Hardware" tab, and click the "Device Manager" button.

##### **Windows 98 SE/Windows Me:**

Select "My Computer" → "Control Panel" → "System," and click "Device Manager."

# Connecting your camcorder to your computer using the USB cable - For Windows users

⑤ Select and delete the underlined devices below.

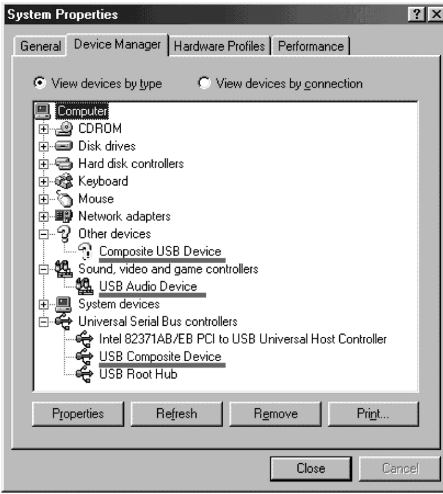

Windows 98SE

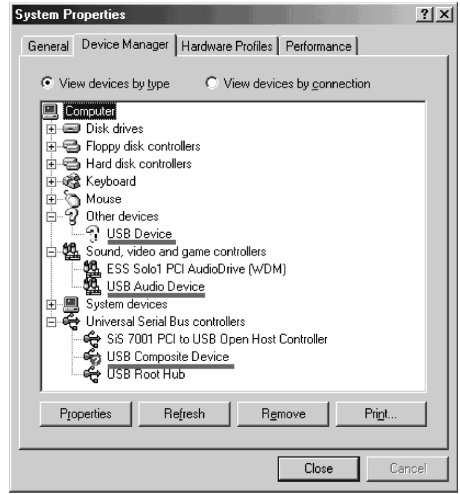

Windows Me

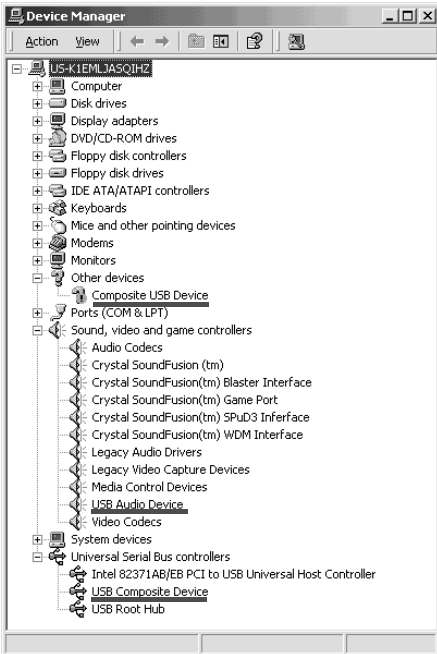

Windows 2000 Professional

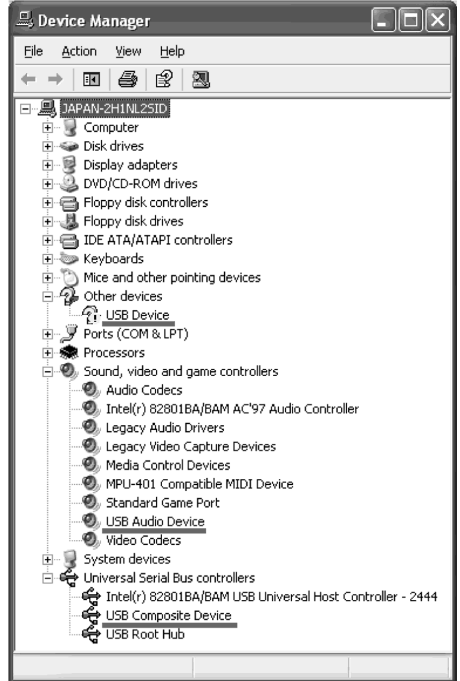

Windows XP Home Edition/Professional



## Connecting your camcorder to your computer using the USB cable – For Windows users

---

- ⑥ Turn the POWER switch to OFF (CHG) on your camcorder, and then disconnect the USB cable.
- ⑦ Restart your computer.

### Step 2: Install the USB driver on the supplied CD-ROM

Perform the entire procedure described in “Installing the USB driver” on page 188.

### Viewing images recorded on a “Memory Stick”

#### Step1: Uninstall the incorrect USB driver

- ① Turn on your computer and allow Windows to load.
- ② Insert a “Memory Stick” into your camcorder.
- ③ Connect the AC power adaptor, and set the POWER switch to MEMORY/ NETWORK (DCR-TRV950 only).
- ④ Connect the USB connector on your computer to the  $\Psi$  (USB) jack on your camcorder using the USB cable supplied with your camcorder.
- ⑤ Open your computer’s “Device Manager.”

#### Windows 2000 Professional:

Select “My Computer” → “Control Panel” → “System” → “Hardware,” and click the “Device Manager” button.

#### Other OS:

Select “My Computer” → “Control Panel” → “System,” and click “Device Manager.”

- ⑥ Select “Other devices.”  
Select the device prefixed with the “?” mark and delete.  
Ex: (?)Sony Handycam
- ⑦ Turn the POWER switch to OFF (CHG) on your camcorder, and then disconnect the USB cable.
- ⑧ Restart your computer.

### Step2: Install the USB driver on the supplied CD-ROM

Perform the entire procedure described in “Installing the USB driver” on page 188.

# Viewing images recorded on a tape on your computer



## - For Windows users

### Capturing images with "PIXELA ImageMixer Ver.1.0 for Sony"

You need to install the USB driver and "PIXELA ImageMixer" to view taped images on your computer (p. 188).

To install and use the software in Windows 2000 Professional, you must be authorized as Power Users or Administrators. For Windows XP Home Edition/Professional, you must be authorized as Administrators.

#### Viewing images recorded on a tape

- (1) Turn on your computer and allow Windows to load.
- (2) Connect the AC power adaptor, and insert a tape into your camcorder.
- (3) Set the POWER switch to VCR.  
Select USB STREAM in  to ON in the menu settings (p. 215).
- (4) Select "Start" → "Programs" → "PIXELA" → "ImageMixer" → "PIXELA ImageMixer Ver.1.0 for Sony."  
The "PIXELA ImageMixer Ver.1.0 for Sony" startup screen appears on your computer. The title screen appears.
- (5) Click  on the screen.



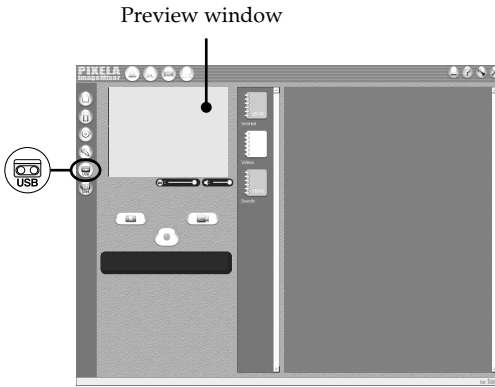

## Viewing images recorded on a tape on your computer - For Windows users

- (6) Select .

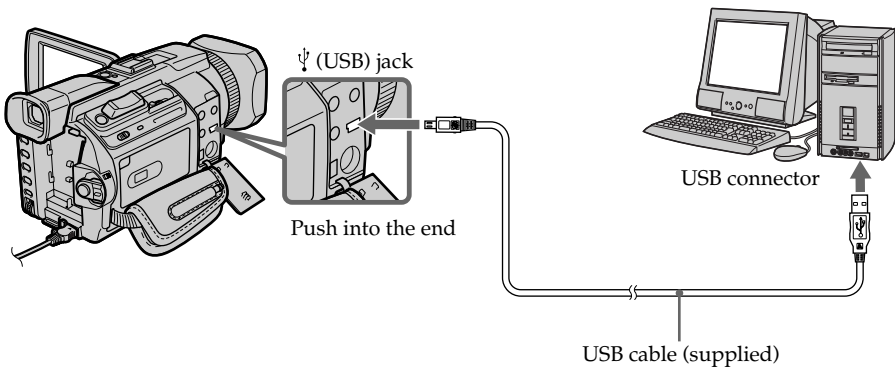

- (7) Connect the  (USB) jack on your camcorder to the USB connector on your computer using the supplied USB cable.



- (8) Press  to start playback.  
The picture from the tape appears on your computer.

## Viewing images recorded on a tape on your computer - For Windows users

---

Viewing pictures live from your camcorder

(1) Follow the steps 1, 2 on page 194.

(2) Set the POWER switch to CAMERA.

Select USB STREAM in  to ON in the menu settings (p. 215).

(3) Follow the steps 4 to 7 on page 194, 195.

The picture from your camcorder appears on the preview window on your computer.

### Capturing still images

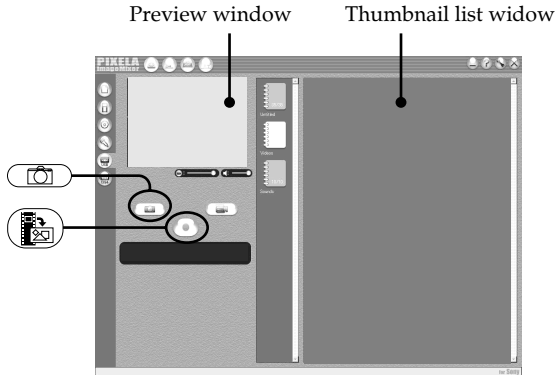

(1) Select  .

(2) Looking at the preview window, move the cursor to  and press it at the point you want to capture.





The still image on the screen is captured.

Captured images are displayed in the thumbnail list window.

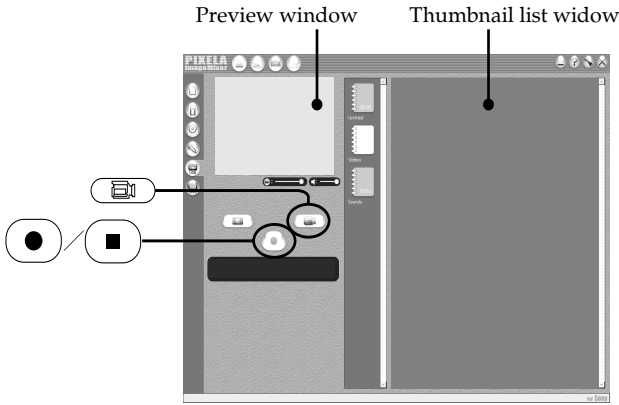
# Viewing images recorded on a tape on your computer - For Windows users

## Capturing moving pictures



- (1) Select .
- (2) Look at the preview window and click on  at the first scene of the movie you want to capture.  changes to .
- (3) Look at the preview window and click on  at the last scene you want to capture. The captured images appear in the thumbnail list window.

### Notes

- The following may occur while using your camcorder, and are not due to any malfunction.
  - The image shakes up and down.
  - Some images are not displayed correctly due to noise, etc.
  - Images of different color systems to that of the camcorder are not displayed correctly.
- When your camcorder is in the standby mode with a cassette inserted, it turns off automatically after five minutes.
- We recommend setting DEMO MODE to OFF in the menu settings when your camcorder is in the standby mode, and no cassette is inserted.
- Indicators in the camcorder LCD screen do not appear on images that are captured into your computer.

## Viewing images recorded on a tape on your computer – For Windows users

---

### If image data cannot be transferred by the USB connection

The USB driver has been registered incorrectly as your computer was connected to your camcorder before installation of the USB driver was completed. Reinstall the USB driver following the procedure on page 191.

### If any trouble occurs

Close all running applications, then restart your computer.

### Carry out the following operations after quitting the application:

- Disconnect the USB cable.
- Change the POWER switch to the other position or set the POWER switch to OFF (CHG) on your camcorder.

## Seeing the on-line help (operating instructions) of “PIXELA ImageMixer Ver.1.0 for Sony”

A “PIXELA ImageMixer Ver.1.0 for Sony” on-line help site is available where you can find the detailed operating method of “PIXELA ImageMixer Ver.1.0 for Sony.”

(1) Click  located in the upper-right corner of the screen.

The ImageMixer’s Manual screen appears.

(2) You can find the information you need from the list of contents.

### To close on-line help

Click  at the top right of the screen.

### If you have any questions about “PIXELA ImageMixer Ver.1.0 for Sony”

“PIXELA ImageMixer Ver.1.0 for Sony” is a software product produced by PIXELA corporation. For more information, refer to the instruction manual of the CD-ROM supplied with your camcorder.

## Notes on using your computer

### Communications with your computer

Communications between your camcorder and your computer may not recover after recovering from Suspend, Resume, or Sleep.

# Viewing images recorded on a “Memory Stick” on your computer

## – For Windows users

### Viewing images

#### Before operation

- You need to install the USB driver to view “Memory Stick” images on your computer (p. 188).  
An application such as Windows Media Player must be installed to play back moving pictures in Windows environment.
- Set USBCONNECT in  to NORMAL in the menu settings. (The default setting is set to NORMAL.)

- (1) Turn on your computer and allow Windows to load.
- (2) Insert a “Memory Stick” into your camcorder, and connect the AC power adaptor to your camcorder.
- (3) Set the POWER switch to MEMORY/NETWORK (DCR-TRV950 only).
- (4) Connect the  (USB) jack on your camcorder to the USB connector on your computer using the supplied USB cable.

USB MODE appears on the LCD screen of your camcorder.

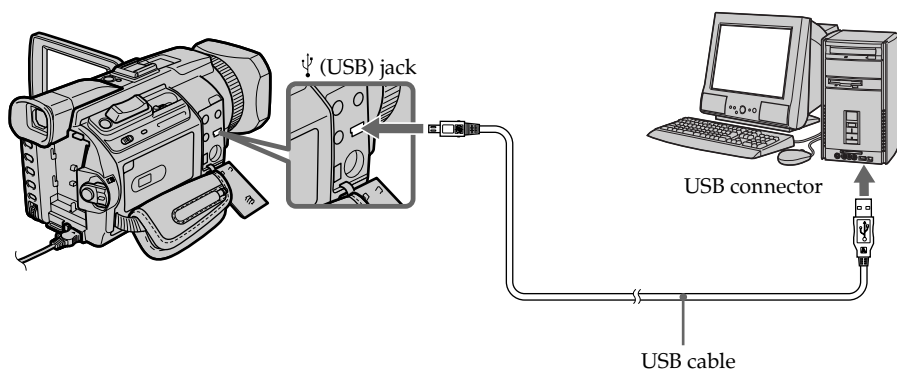

- (5) Open “My Computer” on Windows and double-click the newly recognized drive (Example: “Removable Disk (E:)”).  
The folders inside the “Memory Stick” are displayed.
- (6) Select and double-click the desired image file from the folder.  
For the detailed folder and file name, see “Image file storage destinations and image files” (p. 200).

Desired file type	Double-click in this order
Still image	“Dcim” folder → “100msdcf” folder → Image file
Moving picture*	“Mssony” folder → “Moml0001” folder → Image file*

\* Copying a file to the hard disk of your computer before viewing it is recommended. If you play back the file directly from the “Memory Stick,” the image and sound may break off.

# Viewing images recorded on a “Memory Stick” on your computer – For Windows users

## Image file storage destinations and image files

Image files recorded with your camcorder are grouped in folders by recording mode. The meanings of the file names are as follows. □□□□ stands for any number within the range from 0001 to 9999.

### For Windows Me users (When your camcorder is recognized as the drive [E:])

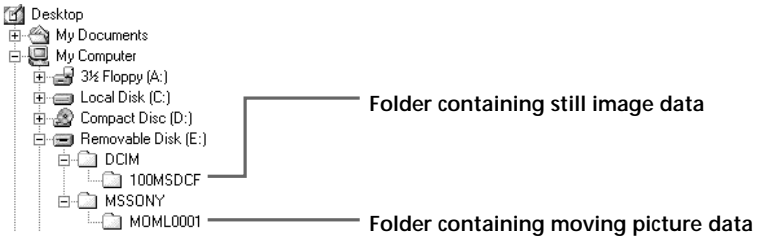

Folder	File	Meaning
100MSDCF	DSC0□□□□.JPG	Still image file
MOML0001	MOV0□□□□.MPG	Moving picture file

## Disconnect the USB cable and eject the “Memory Stick” or set the POWER switch to OFF (CHG)

– For Windows 2000 Professional/Me, Windows XP Home Edition/Professional users

To disconnect the USB cable, eject the “Memory Stick” or set the POWER switch to OFF (CHG) following the procedure below.

- (1) Move the cursor to the “Unplug or Eject Hardware” icon on the Task Tray and click to cancel the applicable drive.
- (2) After the “Safe to remove” message appears, disconnect the USB cable and eject the “Memory Stick” or set the POWER switch to OFF(CHG).



# Connecting your camcorder to your computer using the USB cable – For Macintosh users

---

## When connecting to a computer using the USB jack

Before connecting your camcorder to your computer, **install the USB driver** on the computer. The USB driver is packaged together with application software for viewing images on the CD-ROM supplied with your camcorder.

## Recommended computer usage environment when connecting via USB cable and viewing “Memory Stick” images on your computer

Mac OS 8.5.1/8.6/9.0/9.1/9.2 or Mac OS X (v10.0/v10.1)

Standard installation is required.

However, note that the update to Mac OS 9.0/9.1 should be used for the following models.

- iMac with the Mac OS 8.6 standard installation and a slot loading type CD-ROM drive
- iBook or Power Mac G4 with the Mac OS 8.6 standard installation

The USB connector must be provided as standard.

QuickTime 3.0 or newer must be installed (to play back moving pictures).

---

### Notes

- Operations are not guaranteed for the Macintosh environment if you connect two or more USB equipment to a single computer at the same time, or when using a hub.
- Some equipment may not operate depending on the type of USB equipment that is used simultaneously.
- Operations are not guaranteed for all the recommended computer environments mentioned above.
- Macintosh and Mac OS, QuickTime are trademarks of Apple Computer Inc.
- All other product names mentioned herein may be the trademarks or registered trademarks of their respective companies. Furthermore, “TM” and “®” are not mentioned in each case in this manual.

# Connecting your camcorder to your computer using the USB cable – For Macintosh users

## Installing the USB driver

Do not connect the USB cable to your computer before installation of the USB driver is completed.

For Mac OS 8.5.1/8.6/9.0 users

- (1) Turn on your computer and allow the Mac OS to load.
- (2) Insert the supplied CD-ROM into the CD-ROM drive of your computer.  
The application software screen appears.



- (3) Click the “USB Driver” to open the folder containing the six files related to “Driver.”

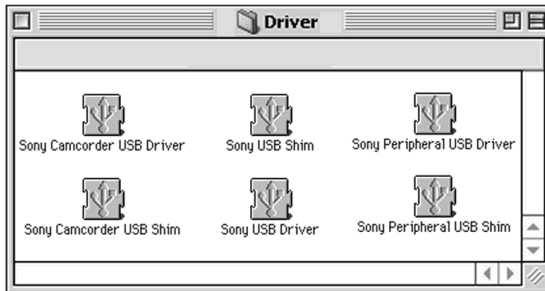

- (4) Select the following two files, and drag and drop them into the System Folder.
  - Sony Camcorder USB Driver
  - Sony Camcorder USB Shim
- (5) When the message appears, click “OK.”  
The USB driver is installed on your computer.
- (6) Remove the CD-ROM from the computer.
- (7) Restart your computer.

For Mac OS 9.1/9.2/Mac OS X (v10.0/v10.1)

The USB driver need not be installed. Your Mac automatically recognizes the “Memory Stick” as a drive just by connecting your Mac using the USB cable.

# Viewing images recorded on a “Memory Stick” on your computer – For Macintosh users

## Viewing images

### Before operation

You need to install the USB driver to view “Memory Stick” images on your computer (p. 202).

QuickTime 3.0 or newer must be installed to play back moving pictures.

- (1) Turn on your computer and allow Mac OS to load.
- (2) Insert a “Memory Stick” into your camcorder, and connect the AC power adaptor to your camcorder.
- (3) Set the POWER switch to MEMORY/NETWORK (DCR-TRV950 only).
- (4) Connect the  $\Psi$  (USB) jack on the camcorder to the USB connector on your computer using the supplied USB cable.  
USB MODE appears on the LCD screen of your camcorder.
- (5) Double-click the “Memory Stick” icon on the desktop.  
The folders inside the “Memory Stick” are displayed.
- (6) Select and double-click the desired image file from the folder.

Desired file type	Double-click in this order
Still image	“Dcim” folder → “100msdcf” folder → Image file
Moving picture*	“Mssonny” folder → “Moml0001” folder → Image file*

\* Copying a file to the hard disk of your computer before viewing it is recommended. If you play back the file directly from the “Memory Stick,” the image and sound may break off.

## Disconnect the USB cable and eject the “Memory Stick” or set the POWER switch to OFF(CHG)

Follow the procedure below.

- (1) Close all running applications.  
Make sure that the access lamp of the hard disk is not lit.
- (2) Drag the “Memory Stick” icon into the “Trash.” Alternatively, select the “Memory Stick” icon by clicking on it, and then select “Eject disk” from the “Special” menu at the top left of the screen.
- (3) Disconnect the USB cable or eject the “Memory Stick” or set the POWER switch of your camcorder to OFF (CHG).

### For Mac OS X (v10.0) users

Shutting down your computer, then disconnect the USB cable and eject the “Memory Stick” or set the POWER switch to OFF (CHG).

# Capturing images from an analog video unit on your computer – Signal convert function

You can capture images and sound from an analog video unit connected to your computer which has the i.LINK jack connected to your camcorder.

## Before operation

Set DISPLAY in  to LCD in the menu settings. (The default setting is LCD.)

- (1) Set the POWER switch to VCR.
- (2) Press MENU, then select A/V → DV OUT in  to ON with the SEL/PUSH EXEC dial (p. 210).
- (3) Start playback on the analog video unit.
- (4) Start procedures for capturing images and sound on your computer. The operation procedures depend on your computer and the software you are using.

For details on how to capture images, refer to the instruction manual of your computer and software you are using.

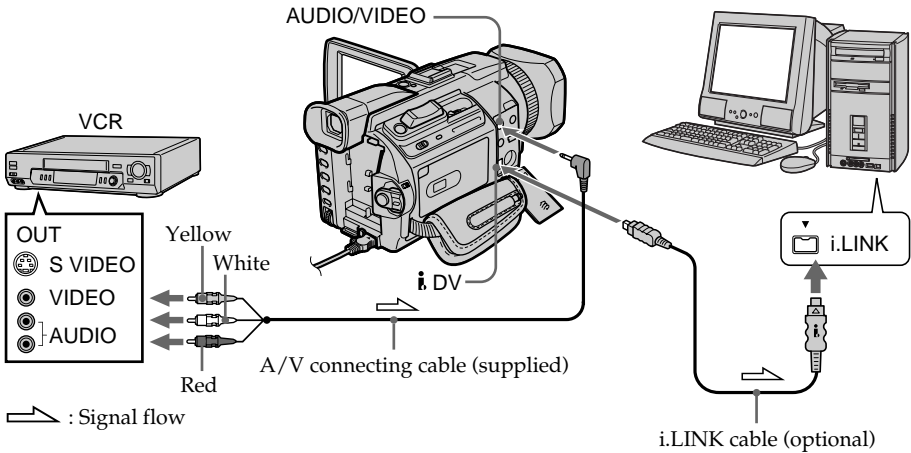

## After capturing images and sound

Stop capturing procedures on your computer, and stop the playback on the analog video unit.

## Notes

- You need to install software that supports the video signal exchange.
- Depending on the state of the video signals, the computer may not be able to output the images correctly when you convert video signals into digital video signals via your camcorder.
- You cannot record or capture the video output via your camcorder when the video tapes include copyright protection signals such as the ID-2 system.
- You can capture images and sound with an S video cable (optional) instead of the A/V connecting cable (supplied).

## If your computer has a USB connector

You can connect using a USB cable, but images may not be transferred smoothly.

# Accessing the network

## – DCR-TRV950 only

You can access the Internet via a Bluetooth compliant device from your camcorder. Once the access is made, you can view a Web page, send/receive your e-mail, etc. This section described only how to open the Network Menu.

(1) Set the POWER switch to MEMORY/NETWORK.

Make sure that the LOCK switch is set to the further side (unlock position).

(2) Press NETWORK.

Ⓜ (Bluetooth) lamp lights up and Network Menu appears.

For the details, refer to the Network Function Operating Instructions supplied with your camcorder.

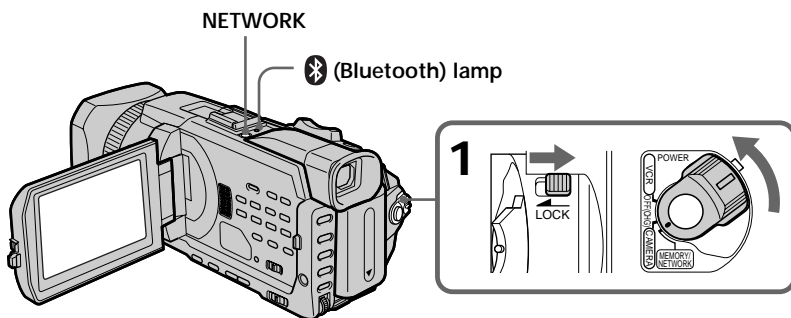

## Accessing the network

---

### How to hold your camcorder when operating in NETWORK mode

Hold your camcorder with your hand through the grip belt to keep from dropping it. The operation buttons needed in NETWORK mode are displayed on the LCD screen. Press the buttons with the supplied stylus.

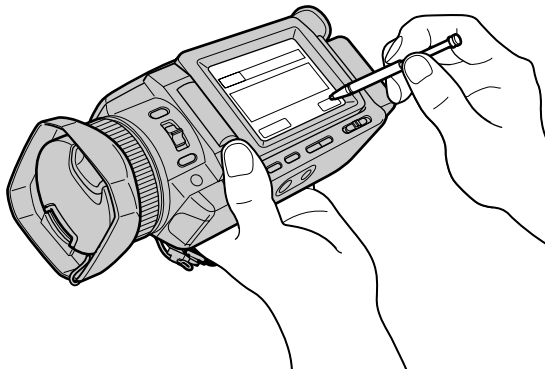

### After using the stylus

Put it back in the holder. Hold the stylus correctly as shown in the illustration and insert it until it clicks.

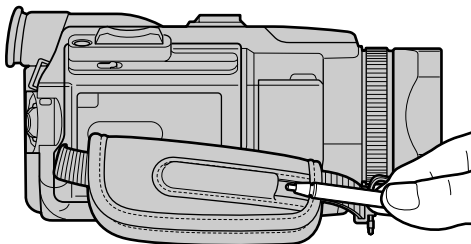

---

### On trademarks

- The BLUETOOTH trademarks are owned by their proprietor and used by Sony Corporation under license.
- All other product names mentioned herein may be the trademarks or registered trademarks of their respective companies. Furthermore, “TM” and “®” are not mentioned in each case in this manual.

### Note

Make sure that your camcorder is in the standby with the POWER switch set to MEMORY/NETWORK.

### During using the network function

You cannot use the optional printer.

# Changing the default settings with the menu

To change the mode settings in the menu settings, select the menu items with the SEL/PUSH EXEC dial. The default settings can be partially changed. First, select the icon, then the menu item and then the mode.

- (1) Set the POWER switch to CAMERA, VCR or MEMORY/NETWORK (DCR-TRV950 only), then press MENU.
- (2) Turn the SEL/PUSH EXEC dial to select the desired icon, then press the dial to set.
- (3) Turn the SEL/PUSH EXEC dial to select the desired item, then press the dial to set.
- (4) Turn the SEL/PUSH EXEC dial to select the desired mode, then press the dial to set.
- (5) If you want to change other items, select  $\leftarrow$  RETURN and press the dial, then repeat steps 2 to 4.

For details, see "Selecting the mode setting of each item" (p. 208).

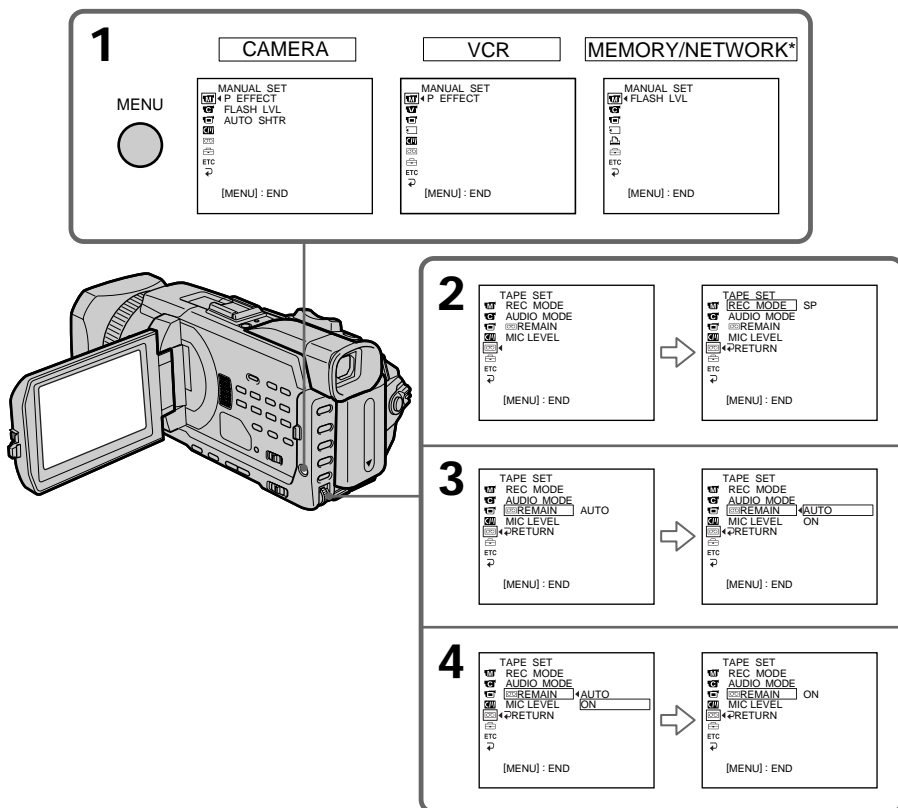

\* DCR-TRV950 only

## Changing the default settings with the menu

### To make the menu display disappear

Press MENU.

Menu items are displayed as the following icons:

-  MANUAL SET
-  CAMERA SET
-  VCR SET
-  LCD/VF SET
-  MEMORY SET
-  PRINT SET
-  CM SET
-  TAPE SET
-  SETUP MENU
-  OTHERS

### Selecting the mode setting of each item ● is the default setting.

Menu items differ depending on the position of the POWER switch. The screen shows only the items you can operate at the moment.

MEMORY / NETWORK is one of the positions of the POWER switch on the DCR-TRV950. It is referred to as MEMORY on the DCR-TRV940.

Icon/item	Mode	Meaning	POWER switch
 MANUAL SET			
P EFFECT	—	To add special effects like those in films or on the TV to images (p. 58, 84)	VCR CAMERA
FLASH LVL	HIGH	Makes the flash level higher than normal.	CAMERA MEMORY / NETWORK
	● NORMAL	Normal setting	
	LOW	Makes the flash level lower than normal.	
AUTO SHTR	● ON	To automatically activate the electronic shutter when shooting in bright conditions	CAMERA
	OFF	To not automatically activate the electronic shutter even when shooting in bright conditions	

#### Note on FLASH LVL

You cannot adjust FLASH LVL if the external flash (optional) is not compatible with the flash level.



## Changing the default settings with the menu

Icon/item	Mode	Meaning	POWER switch
 CAMERA SET			
D ZOOM	● OFF	To deactivate the digital zoom. Up to 12× zoom is performed.	CAMERA
	24×	To activate the digital zoom. More than 12× to 24× zoom is performed digitally (p. 31)	
	150×	To activate the digital zoom. More than 12× to 150× zoom is performed digitally	
PHOTO REC	● MEMORY	To record still images on a “Memory Stick” when you press PHOTO in the tape recording or recording standby (p. 46)	CAMERA
	TAPE	To record still images on a tape when you press PHOTO in the tape recording or recording standby (p. 51)	
16:9WIDE	● OFF	—	CAMERA
	ON	To record a 16:9 wide picture (p. 53)	
STEADYSHOT	● ON	To compensate for camera-shake	CAMERA MEMORY/ NETWORK
	OFF	To cancel the SteadyShot. Natural pictures are produced when shooting a stationary object with a tripod.	
FRAME REC	● OFF	To deactivate Frame recording	CAMERA
	ON	To activate Frame recording (p. 83)	
INT. REC	ON	To activate interval recording (p. 81)	CAMERA
	● OFF	To deactivate interval recording	
	SET	To set the INTERVAL and REC TIME for interval recording	
HOLOGRAM F	● AUTO	The HOLOGRAM AF emits when focusing on subjects is difficult in dark places (p. 141)	MEMORY/ NETWORK
	OFF	The HOLOGRAM AF does not emit.	

### Notes on the SteadyShot

- The SteadyShot will not correct excessive camera-shake.
- Attachment of a conversion lens (optional) may influence the SteadyShot.

### If you cancel the SteadyShot

The SteadyShot off indicator  appears. Your camcorder prevents excessive compensation for camera-shake.

## Changing the default settings with the menu

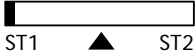
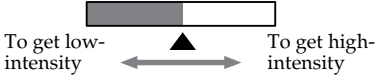
Icon/item	Mode	Meaning	POWER switch
<b>VCR SET</b>			
HiFi SOUND	<input checked="" type="radio"/> STEREO	To play back a stereo tape or dual sound track tape with main and sub sound (p. 229)	VCR
	1	To play back a stereo tape with the left sound or a dual sound tape with main sound	
	2	To play back a stereo tape with the right sound or a dual sound track tape with sub sound	
AUDIO MIX	—	To adjust the balance between the stereo 1 and stereo 2 (p. 118)	VCR
			
A/V→DV OUT	<input checked="" type="radio"/> OFF	To output digital images and sound in analog format using your camcorder	VCR
	ON	To output analog images and sound in digital format using your camcorder (p. 204)	
<b>LCD/VF SET</b>			
LCD B. L.	<input checked="" type="radio"/> BRT NORMAL	To set the brightness on the LCD screen to normal	VCR CAMERA MEMORY/ NETWORK
	BRIGHT	To brighten the LCD screen	
LCD COLOR	—	To adjust the color on the LCD screen, turn the SEL/PUSH EXEC dial.	VCR CAMERA MEMORY/ NETWORK
			
VF B.L.	<input checked="" type="radio"/> BRT NORMAL	To set the brightness on the viewfinder screen to normal	VCR CAMERA MEMORY/ NETWORK
	BRIGHT	To brighten the viewfinder screen	
GUIDEFAME	<input checked="" type="radio"/> OFF	Does not display the guide frame.	CAMERA MEMORY/ NETWORK
	ON	Displays the guide frame (p. 64).	



### Notes on LCD B.L. and VF B.L.

- When you select BRIGHT, battery life is reduced by about 10 percent during recording.
- When you use power supplies other than the battery pack, BRIGHT is automatically selected.

### Even if you adjust LCD B.L., LCD COLOR and/or VF B.L.

The recorded picture will not be affected.

## Changing the default settings with the menu

Icon/item	Mode	Meaning	POWER switch
 MEMORY SET			
STILL SET			
BURST	● OFF	To not record continuously	MEMORY/ NETWORK
	NORMAL	To record from four to 13 images continuously (p. 137)	
	EXP BRKTG	To record three images continuously with different exposure	
	MULTI SCRN	To record nine images continuously, display the images on a single page divided into nine boxes	
QUALITY	● SUPER FINE	To record still images in the finest image quality mode (p. 131)	VCR MEMORY/ NETWORK
	FINE	To record still images in the fine image quality mode	
	STANDARD	To record still images in the standard image quality mode	
IMAGESIZE	● 1152 × 864	To record still images at 1152 × 864 size (p. 133)	MEMORY/ NETWORK
	640 × 480	To record still images at 640 × 480 size	
MOVIE SET			
IMAGESIZE	● 320 × 240	To record moving pictures at 320 × 240 size (p. 133).	VCR MEMORY/ NETWORK
	160 × 112	To record moving pictures at 160 × 112 size.	
 REMAIN	● AUTO	To display the remaining capacity of the "Memory Stick" in the following cases: <ul style="list-style-type: none"> <li>• For five seconds after setting the POWER switch to MEMORY/NETWORK (DCR-TRV950 only) or VCR</li> <li>• For five seconds after setting the POWER switch to MEMORY/NETWORK (DCR-TRV950 only) or VCR and inserting a "Memory Stick"</li> <li>• When the remaining capacity of the "Memory Stick" is less than two minutes after setting the POWER switch to MEMORY/NETWORK (DCR-TRV950 only)</li> <li>• For five seconds from the start of moving picture recording</li> <li>• For five seconds after completing a moving picture recording</li> </ul>	VCR MEMORY/ NETWORK
	ON	To always display the remaining capacity of the "Memory Stick"	

### When you select QUALITY

The number of the recording pictures is displayed.



## Changing the default settings with the menu

Icon/item	Mode	Meaning	POWER switch
 MEMORY SET			
PHOTO SAVE	—	To copy still images on the tape onto the “Memory Stick” (p. 163)	VCR
FILE NO.	● SERIES	To assign numbers to file in sequence even if the “Memory Stick” is changed	VCR MEMORY/ NETWORK
	RESET	To reset the file numbering each time the “Memory Stick” is changed	
DELETE ALL	—	To delete all unprotected images (p. 179)	MEMORY/ NETWORK
FORMAT	● RETURN	To cancel formatting	MEMORY/ NETWORK
	OK	To format an inserted “Memory Stick” Formatting erases all information on the “Memory Stick” Check the contents of the “Memory Stick” before formatting. 1. Select FORMAT. 2. Select OK with the SEL/PUSH EXEC dial, then press the dial. 3. After EXECUTE appears, press SEL/PUSH EXEC dial. FORMATTING flashes during formatting. COMPLETE appears when formatting is finished.	

### Notes on formatting

- Do not do any of the following while FORMATTING is displayed:
  - Switch the POWER switch.
  - Operate buttons.
  - Eject the “Memory Stick.”
- The supplied or optional “Memory Stick” has been formatted at factory. Formatting the “Memory Stick” on your camcorder is not required.
- You cannot format the “Memory Stick” if the write-protect switch on the “Memory Stick” is set to LOCK.
- Format the “Memory Stick” when “ FORMAT ERROR” is displayed.
- Formatting erases protected image data on the “Memory Stick.”



## Changing the default settings with the menu

Icon/item	Mode	Meaning	POWER switch
 PRINT SET			
DATE/TIME	● OFF	To make prints without the recording date and time	MEMORY/ NETWORK
	DATE	To make prints with the recording date (p. 181)	
	DAY&TIME	To make prints with the recording date and time	
 CM SET			
TITLE	—	To superimpose a title or make your own title (p. 119, 122)	VCR CAMERA
TITLEERASE	—	To erase the title you have superimposed (p. 121)	VCR CAMERA
TITLE DSPL	● ON	To display the title you have superimposed	VCR
	OFF	To not display the title	
CM SEARCH	● ON	To search using cassette memory (p. 89, 90, 92)	VCR
	OFF	To search without using cassette memory	
TAPE TITLE	—	To label a cassette (p. 124)	VCR CAMERA
ERASE ALL	—	To erase all the data in cassette memory (p. 125)	VCR CAMERA

### Note on PRINT SET

DATE/TIME is displayed only when an external printer (optional) is connected to the intelligent accessory shoe.

## Changing the default settings with the menu

Icon/item	Mode	Meaning	POWER switch
 TAPE SET			
REC MODE	● SP	To record in the SP (Standard Play) mode	VCR CAMERA
	LP	To increase the recording time to 1.5 times the SP mode	
AUDIO MODE	● 12BIT	To record in the 12-bit mode (two stereo sounds)	VCR CAMERA
	16BIT	To record in the 16-bit mode (one stereo sound with high quality)	
 REMAIN	● AUTO	To display the remaining tape bar: <ul style="list-style-type: none"> <li>• For about eight seconds after a cassette is inserted and your camcorder calculates the remaining amount of tape</li> <li>• For about eight seconds after  or DISPLAY/TOUCH PANEL is pressed</li> </ul>	VCR CAMERA
	ON	To always display the remaining tape indicator	
MIC LEVEL	● AUTO	Adjusts audio recording level automatically	VCR CAMERA
	MANUAL	Adjusts audio recording level manually	

### Notes on the LP mode

- When you record a tape in the LP mode on your camcorder, we recommend playing the tape on your camcorder. When you play back the tape on other camcorders or VCRs, noise may occur in pictures or sound.
- When you record in the LP mode, we recommend using a Sony Excellence/Master cassette so that you can get the most out of your camcorder.
- You cannot dub audio on a tape recorded in the LP mode. Use the SP mode for the tape to be audio dubbed.
- When you record in the SP and LP modes on one tape or you record some scenes in the LP mode, the playback picture may be distorted or the time code may not be written properly between scenes.

### Notes on AUDIO MODE

- You cannot dub audio on a tape recorded in the 16-bit mode.
- When playing back a tape recorded in the 16-bit mode, you cannot adjust the balance in AUDIO MIX.

## Changing the default settings with the menu

Icon/item	Mode	Meaning	POWER switch
 <b>SETUP MENU</b>			
<b>CLOCK SET</b>	—	To set the date or time (p. 20).	CAMERA MEMORY/ NETWORK
<b>USB STREAM</b>	● OFF	To deactivate the USB streaming	VCR CAMERA
	ON	To activate the USB streaming	
<b>USBCONNECT</b>	● NORMAL	To connect and recognize the “Memory Stick” drive.	MEMORY/ NETWORK
	PTP	To connect and only copy a “Memory Stick” image from your camcorder to a computer (only with Windows XP or Mac OS X) 1. Turn the SEL/PUSH EXEC dial to select “USB CONNECT” followed by “PTP”, then press the dial to set. 2. Insert the “Memory Stick” into the camcorder, and connect the camcorder to the computer using a USB cable. Copy Wizard will automatically start up.	
<b>LTR SIZE</b>	● NORMAL	To display selected menu items in normal size	VCR CAMERA MEMORY/ NETWORK
	2×	To display selected menu items at twice the normal size	
<b>LANGUAGE</b>	● ENGLISH	To display the following information indicators in English: min, REC, STBY and START	VCR CAMERA
	FRANÇAIS	To display the information indicators in French	MEMORY/ NETWORK
	ESPAÑOL	To display the information indicators in Spanish	
	PORTUGUÊS	To display the information indicators in Portuguese	
	中文	To display the information indicators in Chinese	
	한국어	To display the information indicators in Korean	
<b>DEMO MODE</b>	● ON	To make the demonstration appear	CAMERA
	OFF	To cancel the demonstration	

### Notes on DEMO MODE

- You cannot select DEMO MODE when a cassette or a “Memory Stick” is inserted in your camcorder.
- You cannot select DEMO MODE when the color bar is displayed. When you press the COLOR BAR button during demonstration, DEMO MODE is canceled.
- The DEMO MODE default setting is STBY (Standby) and the demonstration starts about 10 minutes after you have set the POWER switch to CAMERA without a cassette or a “Memory Stick” inserted.

To cancel the demonstration, insert a cassette or a “Memory Stick,” set the POWER switch to other than CAMERA, or set DEMO MODE to OFF. To set to STBY (Standby) again, leave the DEMO MODE at ON in the menu settings, turn the POWER switch to OFF (CHG), and return the POWER switch to CAMERA.

(continued on the following page)

## Changing the default settings with the menu

Icon/item	Mode	Meaning	POWER switch
<b>ETC OTHERS</b>			
<b>DATA CODE</b>	● DATE/CAM	To display date, time and various settings during playback when pressing the DATA CODE button (p. 41)	VCR MEMORY/ NETWORK
	DATE	To display date and time during playback when pressing the DATA CODE button	
<b>AREA SET</b>	—	Temporarily change the area where you are using your camcorder	CAMERA MEMORY/ NETWORK
<b>DST SET*</b>	● OFF	Not during daylight saving time	CAMERA MEMORY/ NETWORK
	ON	During daylight saving time	
<b>BEEP</b>	● MELODY	To output the melody when you start/stop recording or when an unusual condition occurs on your camcorder	VCR CAMERA MEMORY/ NETWORK
	NORMAL	To output the beep instead of the melody	
	OFF	To cancel all sound including shutter sound	
<b>COMMANDER</b>	● ON	To activate the Remote Commander supplied with your camcorder	VCR CAMERA MEMORY/ NETWORK
	OFF	To deactivate the Remote Commander to avoid remote control operation caused by other VCR's remote control	

\* Instead of DST, SUMMERTIME is displayed on the screen for some models.



## Changing the default settings with the menu

Icon/item	Mode	Meaning	POWER switch
<b>ETC OTHERS</b>			
<b>DISPLAY</b>	● LCD	To show the display on the LCD screen and in the viewfinder	VCR CAMERA MEMORY/ NETWORK
	V-OUT/LCD	To show the display on the TV screen, LCD screen and in the viewfinder	
<b>REC LAMP</b>	● ON	To light up the camera recording lamp at the front of your camcorder	CAMERA MEMORY/ NETWORK
	OFF	To turn the camera recording lamp off so that the person is not aware of the recording	
<b>VIDEO EDIT</b>	● RETURN	To cancel video editing.	VCR
	TAPE	To make program and dub on the tape in the other VCR (p. 98)	
	MEMORY	To make program and dub on a "Memory Stick" (p. 160)	

### Note

If you press DISPLAY/TOUCH PANEL with DISPLAY set to V-OUT/LCD in the menu settings, the picture from a TV or VCR will not appear on the LCD screen even when your camcorder is connected to outputs on the TV or VCR.

### When recording a close subject

When REC LAMP is set to ON, the red camera recording lamp on the front of the camcorder may reflect on the subject if it is close. In this case, we recommend that you set REC LAMP to OFF.

### In more than five minutes after removing the power supply

The FLASH LVL, HiFi SOUND, AUDIO MIX, MIC LEVEL and COMMANDER settings are returned to their default settings.

Other menu settings are held in memory even after removing the power supply.

# Types of trouble and how to correct trouble

If you run into any problem using your camcorder, use the following table to troubleshoot the problem. If the problem persists, remove the power supply and contact your Sony dealer or local authorized Sony service facility. If “C:□□:□□” appears on the screen, the self-diagnosis display function has worked. See page 225.

## In the recording

Symptom	Cause and/or Corrective Actions
START/STOP does not operate.	<ul style="list-style-type: none"> <li>• The POWER switch is not set to CAMERA. → Set it to CAMERA (p. 26).</li> <li>• The tape has run out. → Rewind the cassette or insert a new one (p. 23, 43).</li> <li>• The write-protect tab is set to expose the red mark. → Use a new tape or slide the tab (p. 23).</li> <li>• The tape is stuck to the drum (moisture condensation). → Remove the cassette and leave your camcorder for at least one hour to acclimatize (p. 236).</li> </ul>
The power goes off.	<ul style="list-style-type: none"> <li>• While being operated when the POWER switch is set to CAMERA, your camcorder has been in the standby for more than five minutes. → Set the POWER switch to OFF (CHG) and then to CAMERA.</li> <li>• The battery pack is dead or nearly dead. → Install a charged battery pack.</li> </ul>
You cannot record still images on a “Memory Stick” in the recording or recording standby.	<ul style="list-style-type: none"> <li>• PHOTO REC is set to TAPE in menu settings. → Set it to MEMORY (p. 209).</li> </ul>
You cannot record still images on a tape.	<ul style="list-style-type: none"> <li>• PHOTO REC is set to MEMORY in menu settings. → Set it to TAPE (p. 209).</li> </ul>
The image on the viewfinder screen is not clear.	<ul style="list-style-type: none"> <li>• The viewfinder lens is not adjusted. → Adjust the viewfinder lens (p. 30).</li> </ul>
The SteadyShot does not work.	<ul style="list-style-type: none"> <li>• STEADYSHOT is set to OFF in the menu settings. → Set it to ON (p. 209).</li> </ul>
The autofocusing does not work.	<ul style="list-style-type: none"> <li>• The setting is the manual focus. → Set FOCUS to AUTO (p. 76).</li> <li>• Shooting conditions are not suitable for autofocus. → Adjust for manual focusing (p. 76).</li> </ul>

## Types of trouble and how to correct trouble

Symptom	Cause and/or Corrective Actions
The picture does not appear in the viewfinder.	<ul style="list-style-type: none"> <li>• The LCD panel is open. → Close the LCD panel (p. 28).</li> </ul>
A vertical band appears when you shoot a subject such as lights or a candle flame against a dark background.	<ul style="list-style-type: none"> <li>• The contrast between the subject and background is too high. This is not a malfunction.</li> </ul>
A vertical band appears when you shoot a very bright subject.	<ul style="list-style-type: none"> <li>• This is not a malfunction.</li> </ul>
Some tiny white, red, blue or green spots appear on the screen.	<ul style="list-style-type: none"> <li>• The shutter speed is reduced. This is not a malfunction.</li> </ul>
An unknown picture is displayed on the screen.	<ul style="list-style-type: none"> <li>• If 10 minutes elapse after you set the POWER switch to CAMERA or DEMO MODE is set to ON in the menu settings when neither a cassette nor a "Memory Stick" is inserted, your camcorder automatically starts the demonstration. → Insert a cassette or a "Memory Stick" and the demonstration stops. You can also cancel DEMO MODE (p. 215).</li> </ul>
The picture appears too bright, and the subject does not appear on the screen.	<ul style="list-style-type: none"> <li>• The backlight is active. → Set it off (p. 34).</li> </ul>
The click of the shutter does not sound.	<ul style="list-style-type: none"> <li>• BEEP is set to OFF in the menu settings. → Set it to MELODY or NORMAL (p. 216).</li> </ul>
Black bands appear when you record TV or computer screen.	<ul style="list-style-type: none"> <li>• Set the STEADYSHOT in the menu settings to OFF (p. 209).</li> </ul>
An external flash (optional) does not work.	<ul style="list-style-type: none"> <li>• The power of the external flash is off or the power supply is not installed. → Turn on the external flash or install the power supply.</li> <li>• Two or more external flashes (optional) are attached. → Only one external flash (optional) can be attached.</li> </ul>
The image is not bright with video flash light (optional).	<ul style="list-style-type: none"> <li>• The manual adjustment is not suitable for the situations (The  indicator flashes). → Set the AUTO LOCK selector to AUTO LOCK, or cancel the manual adjustment (p. 67).</li> </ul>





## Types of trouble and how to correct trouble

### In the playback

Symptom	Cause and/or Corrective Actions
The tape does not move when a video control button is pressed.	<ul style="list-style-type: none"><li>• The POWER switch is not set to VCR. → Set it to VCR (p. 39).</li></ul>
The playback button does not work.	<ul style="list-style-type: none"><li>• The cassette has run out of the tape. → Rewind the tape (p. 39).</li></ul>
There are horizontal lines on the picture, or the playback picture is not clear or does not appear.	<ul style="list-style-type: none"><li>• The video heads may be dirty. → Clean the heads using the cleaning cassette (optional) (p. 237).</li></ul>
No sound or only a low sound is heard when playing back a tape.	<ul style="list-style-type: none"><li>• The stereo tape is played back with HiFi SOUND set to 2 in the menu settings. → Set it to STEREO (p. 210).</li><li>• The volume is turned to minimum. → Turn up the volume (p. 39).</li><li>• AUDIO MIX is set to ST2 in the menu settings. → Adjust AUDIO MIX (p. 210).</li></ul>
Displaying the recorded date, DATE SEARCH does not work.	<ul style="list-style-type: none"><li>• The cassette has no cassette memory. → Use a cassette with cassette memory (p. 90).</li><li>• CM SEARCH is set to OFF in the menu settings. → Set it to ON (p. 213).</li><li>• The tape has a blank portion between recorded portions (p. 91).</li></ul>
TITLE SEARCH does not work.	<ul style="list-style-type: none"><li>• The cassette has no cassette memory. → Use a cassette with cassette memory (p. 89).</li><li>• CM SEARCH is set to OFF in the menu settings. → Set it to ON (p. 213).</li><li>• There is no title in the tape. → Superimpose the titles (p. 119).</li><li>• The tape has a blank portion between recorded portions (p. 89).</li></ul>
The new sound added to the recorded tape is not heard.	<ul style="list-style-type: none"><li>• AUDIO MIX is set to the ST1 side in the menu settings. → Adjust AUDIO MIX (p. 118).</li></ul>
The title is not displayed.	<ul style="list-style-type: none"><li>• TITLE DSPL is set to OFF in the menu settings. → Set it to ON (p. 213).</li></ul>

## Types of trouble and how to correct trouble

### In the recording and playback

Symptom	Cause and/or Corrective Actions
The power does not turn on.	<ul style="list-style-type: none"><li>• The battery pack is not installed, or is dead or nearly dead. → Install a charged battery pack (p. 15, 16).</li><li>• The AC power adaptor is not connected to a wall outlet. → Connect the AC power adaptor to a wall outlet (p. 19).</li></ul>
The end search does not work.	<ul style="list-style-type: none"><li>• The tape was ejected after recording when using a cassette without cassette memory (p. 37).</li><li>• You have not recorded on the new cassette yet (p. 37).</li></ul>
The end search does not work correctly.	<ul style="list-style-type: none"><li>• The tape has a blank portion at the beginning or midway (p. 37).</li></ul>
The battery pack is quickly discharged.	<ul style="list-style-type: none"><li>• The operating temperature is too low.</li><li>• The battery pack is not fully charged. → Charge the battery pack fully again (p. 16).</li><li>• The battery pack is completely dead, and cannot be recharged. → Replace with a new battery pack (p. 15).</li></ul>
The battery remaining time indicator does not indicate the correct time.	<ul style="list-style-type: none"><li>• You have used the battery pack in an extremely hot or cold environment for a long time.</li><li>• The battery pack is completely dead, and cannot be recharged. → Replace with a new battery pack (p. 15).</li><li>• The battery is not fully charged. → Install a charged battery pack (p. 15, 16).</li><li>• A deviation has occurred in the remaining battery time. → Charge the battery pack fully again so that the indication on the battery remaining indicator is correct (p. 16).</li></ul>
The power goes off although the battery remaining time indicator indicates that the battery pack has enough power to operate.	<ul style="list-style-type: none"><li>• A deviation has occurred in the remaining battery time. → Charge the battery pack fully again so that the indication on the battery remaining battery time indicator is correct (p. 16).</li></ul>
The cassette cannot be removed from the holder.	<ul style="list-style-type: none"><li>• The power supply is disconnected. → Connect it firmly (p. 15, 19).</li><li>• The battery is dead. → Use a charged battery pack (p. 15, 16).</li></ul>
The  and  indicators flash and no functions except for cassette ejection work.	<ul style="list-style-type: none"><li>• Moisture condensation has occurred. → Remove the cassette and leave your camcorder for at least one hour to acclimatize (p. 236).</li></ul>
 indicator does not appear when using a cassette with cassette memory.	<ul style="list-style-type: none"><li>• The gold-plated connector of the tape is dirty or dusty. → Clean the gold-plated connector (p. 230).</li></ul>
Remaining tape indicator is not displayed.	<ul style="list-style-type: none"><li>• The  REMAIN is set to AUTO in the menu settings. → Set it to ON to always display the remaining tape indicator (p. 214).</li></ul>

## Types of trouble and how to correct trouble

### When operating using the "Memory Stick"

Symptom	Cause and/or Corrective Actions
The "Memory Stick" does not function.	<ul style="list-style-type: none"><li>• The POWER switch is not set to MEMORY/NETWORK (DCR-TRV950 only). → Set it to MEMORY/NETWORK (DCR-TRV950 only) (p. 129).</li><li>• The "Memory Stick" is not inserted. → Insert a "Memory Stick" (p. 128).</li></ul>
Recording does not function.	<ul style="list-style-type: none"><li>• The "Memory Stick" has already been full. → Delete unnecessary images and record again (p. 177).</li><li>• The "Memory Stick" formatted incorrectly is inserted. → Format the "Memory Stick" or use another "Memory Stick" (p. 128, 212).</li><li>• The write-protect switch on the "Memory Stick" is set to LOCK. → Release the lock (p. 126).</li></ul>
The image cannot be deleted.	<ul style="list-style-type: none"><li>• The image is protected. → Cancel image protection (p. 176).</li><li>• The write-protect switch on the "Memory Stick" is set to LOCK. → Release the lock (p. 126).</li></ul>
You cannot format the "Memory Stick."	<ul style="list-style-type: none"><li>• The write-protect switch on the "Memory Stick" is set to LOCK. → Release the lock (p. 126).</li></ul>
Deleting all the images cannot be carried out.	<ul style="list-style-type: none"><li>• The write-protect switch on the "Memory Stick" is set to LOCK. → Release the lock (p. 126).</li></ul>
You cannot protect the image.	<ul style="list-style-type: none"><li>• The write-protect switch on the "Memory Stick" is set to LOCK. → Release the lock (p. 126).</li><li>• INDEX screen is not displayed. → Press INDEX to display the INDEX screen and protect the image (p. 176).</li></ul>
You cannot write a print mark on the still image.	<ul style="list-style-type: none"><li>• The write-protect switch on the "Memory Stick" is set to LOCK. → Release the lock (p. 126).</li><li>• INDEX screen is not displayed. → Press INDEX to display the INDEX screen and write the print marks on the screen (p. 180).</li><li>• You are trying to write a print mark on a moving picture. → Print marks cannot be written on a moving picture (p. 180).</li></ul>
PHOTO SAVE does not work.	<ul style="list-style-type: none"><li>• The write-protect switch on the "Memory Stick" is set to LOCK. → Release the lock (p. 126).</li></ul>
You cannot play back images in actual size.	<ul style="list-style-type: none"><li>• You may not be able to play back images in actual size when you try to play back images recorded by other equipment. This is not a malfunction.</li></ul>
You cannot play back image data.	<ul style="list-style-type: none"><li>• Your camcorder cannot play back some images processed with a computer (The file name will blink).</li><li>• If you record images with any other equipment, the images may not play back normally on your camcorder.</li></ul>

## Types of trouble and how to correct trouble

### Others

Symptom	Cause and/or Corrective Actions
The title is not recorded.	<ul style="list-style-type: none"><li>• The cassette has no cassette memory. → Use a cassette with cassette memory (p. 119).</li><li>• The cassette memory is full. → Erase unwanted titles (p. 121).</li><li>• The cassette is set to prevent accidental erasure. → Slide the write-protect tab so that red portion is not visible (p. 23).</li><li>• The tape has a blank portion between recorded portions. → Superimpose the title to recorded positions (p. 120).</li></ul>
The cassette label is not recorded.	<ul style="list-style-type: none"><li>• The cassette has no cassette memory. → Use a cassette with cassette memory (p. 124).</li><li>• The cassette memory is full. → Erase unwanted data (p. 121,125).</li><li>• The tape is set to prevent accidental erasure. → Slide the write-protect tab so that red mark is not visible (p. 23).</li></ul>
Digital program editing to a tape does not function.	<ul style="list-style-type: none"><li>• The input selector on the VCR is not set correctly. → Check the connection and set the input selector on the VCR again (p. 98)</li><li>• The camcorder is connected to DV equipment of other than Sony using the i.LINK cable. → Set it to IR (p. 99).</li><li>• You have attempted to set a program on a blank portion of the tape. → Set the program again on a recorded portion (p. 106).</li><li>• The camcorder and the VCR are not synchronized. → Adjust the synchronization (p. 104).</li><li>• The IR SETUP code is incorrect. → Set the correct code (p. 100).</li></ul>
Digital program editing to a "Memory Stick" does not function.	<ul style="list-style-type: none"><li>• Setting program on a blank portion of the tape is attempted. → Set the program again on a recorded portion (p. 160).</li></ul>
The Remote Commander supplied with your camcorder does not work.	<ul style="list-style-type: none"><li>• COMMANDER is set to OFF in the menu settings. → Set it to ON (p. 216).</li><li>• Something is blocking the infrared rays. → Remove the obstacle.</li><li>• The batteries are inserted with + and – incorrectly matching + and – inside the battery compartment. → Insert the batteries correctly (p. 251).</li><li>• The batteries are dead. → Insert new ones (p. 251).</li></ul>
The picture from a TV or VCR does not appear even when your camcorder is connected to output on the TV or VCR.	<ul style="list-style-type: none"><li>• DISPLAY is set to V-OUT/LCD in the menu settings. → Set it to LCD (p. 217).</li></ul>

## Types of trouble and how to correct trouble

Symptom	Cause and/or Corrective Actions
The cassette cannot be removed even if the cassette lid is open.	<ul style="list-style-type: none"> <li>Moisture has started to condense in your camcorder (p. 236).</li> </ul>
The melody or beep sounds for five seconds.	<ul style="list-style-type: none"> <li>Moisture condensation has occurred.                             <ul style="list-style-type: none"> <li>→ Remove the cassette and leave your camcorder for at least one hour to acclimatize (p. 236).</li> </ul> </li> <li>Some troubles have occurred in your camcorder.                             <ul style="list-style-type: none"> <li>→ Remove the cassette and insert it again, then operate your camcorder.</li> </ul> </li> </ul>
When you set the POWER switch to VCR or OFF (CHG), if you move your camcorder, you may hear a clattering sound from inside your camcorder.	<ul style="list-style-type: none"> <li>This is because some functions use a linear mechanism. Your camcorder is not malfunctioning.</li> </ul>
You cannot charge the battery pack.	<ul style="list-style-type: none"> <li>The POWER switch is not set to OFF (CHG).                             <ul style="list-style-type: none"> <li>→ Set it to OFF (CHG) (p. 16).</li> </ul> </li> </ul>
While charging the battery pack, no indicator appears, the indicator flashes in the display window.	<ul style="list-style-type: none"> <li>The battery pack is not properly installed.                             <ul style="list-style-type: none"> <li>→ Install it properly (p. 15).</li> </ul> </li> <li>Something is wrong with the battery pack.                             <ul style="list-style-type: none"> <li>→ Please contact your Sony dealer or local authorized Sony service facility.</li> </ul> </li> </ul>
No function works though the power is on.	<ul style="list-style-type: none"> <li>Disconnect the power cord of the AC power adaptor or remove the battery, then reconnect it in about one minute. Turn the power on. If the functions still do not work, press the RESET button using a sharp-pointed object (If you press the RESET button, all the settings including the date and time return to their defaults.) (p. 15, 19, 245).</li> </ul>
The buttons do not appear on the touch panel.	<ul style="list-style-type: none"> <li>The DISPLAY/TOUCH PANEL button is pressed.                             <ul style="list-style-type: none"> <li>→ Press the LCD screen lightly.</li> <li>→ Press the DISPLAY/TOUCH PANEL button on your camcorder or the DISPLAY button on the Remote Commander (p. 41).</li> </ul> </li> </ul>
The buttons on the LCD screen do not work.	<ul style="list-style-type: none"> <li>Adjust the screen (CALIBRATION) (p. 238).</li> </ul>
The indicators appear mirror-reversed in the viewfinder or on the TV screen.	<ul style="list-style-type: none"> <li>The mirror mode is activated. This is not a malfunction (p. 32).</li> </ul>
Image data cannot be transferred by the USB connection.	<ul style="list-style-type: none"> <li>The USB cable was connected before installation of the USB driver was completed.                             <ul style="list-style-type: none"> <li>→ Uninstall the incorrect USB driver and re-install the USB driver (p. 188, 191, 202).</li> </ul> </li> <li>USBCONNECT is set to PTP in the menu settings when the POWER switch is set to MEMORY/NETWORK (DCR-TRV950 only).                             <ul style="list-style-type: none"> <li>→ Set it to NORMAL (p. 215).</li> </ul> </li> </ul>



# Self-diagnosis display

Your camcorder has a self-diagnosis display function.

This function displays the current state of your camcorder as a 5-digit code (a combination of a letter and figures) on the screen. If a 5-digit code is displayed, check the following list of codes. The last two digits (indicated by □□) differ depending on the state of your camcorder.

## LCD screen, Viewfinder or Display window

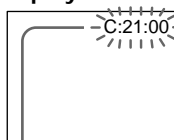

### Self-diagnosis display

- C:□□:□□  
You can service your camcorder yourself.
- E:□□:□□  
Contact your Sony dealer or local authorized Sony service facility.

Five-digit display	Cause and/or Corrective Actions
C:04:□□	<ul style="list-style-type: none"> <li>• You are using a battery pack that is not an "InfoLITHIUM" battery pack. → Use an "InfoLITHIUM" battery pack (p. 18, 231).</li> </ul>
C:21:□□	<ul style="list-style-type: none"> <li>• Moisture condensation has occurred. → Remove the cassette and leave your camcorder for at least one hour to acclimatize (p. 236).</li> </ul>
C:22:□□	<ul style="list-style-type: none"> <li>• The video heads are dirty. → Clean the heads using the cleaning cassette (optional) (p. 237).</li> </ul>
C:31:□□ C:32:□□	<ul style="list-style-type: none"> <li>• A malfunction other than the above that you can service has occurred. → Remove the cassette and insert it again, then operate your camcorder. → Disconnect the power cord of the AC power adaptor or remove the battery pack. After reconnecting the power supply, operate your camcorder.</li> </ul>
E:20:□□ E:61:□□ E:62:□□ E:91:□□	<ul style="list-style-type: none"> <li>• A malfunction that you cannot service has occurred. → Contact your Sony dealer or local authorized Sony service facility and inform them of the 5-digit code (example: E:61:10).</li> </ul>

If you are unable to rectify the problem even if you try corrective actions a few times, contact your Sony dealer or local authorized Sony service facility.

# Warning indicators and messages

If indicators and messages appear on the screen or in the display window, check the following:

See the page in parentheses “( )” for more information.

## Warning indicators

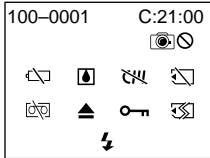

### 100-0001 Warning indicator pertaining to files

Slow flashing:

- The file is corrupted.
- The file is unreadable.
- You are trying to use the MEMORY MIX on a moving picture (p. 148).

### C:21:00 Self-diagnosis display (p. 225).

#### The battery is dead or nearly dead

Slow flashing:

- The battery is nearly dead. Depending on the operating conditions, environment and battery condition, the  indicator may flash even if there are approximately five to 10 minutes remaining.

Fast flashing:

- The battery is dead (p. 16).

#### Moisture condensation has occurred\*

Fast flashing:

- Eject the cassette, turn off your camcorder, and leave it for about one hour with the cassette compartment open (p. 236).

#### Warning indicator pertaining to cassette memory\*

Slow flashing:

- No cassette with cassette memory is inserted (p. 228).

#### Warning indicator pertaining to the “Memory Stick”

Slow flashing:

- No “Memory Stick” is inserted.

Fast flashing\*:

- The “Memory Stick” is not readable on your camcorder (p. 126).
- The image cannot be recorded on the “Memory Stick.”

#### Warning indicator pertaining to “Memory Stick” formatting\*

Fast flashing:

- The “Memory Stick” is not formatted correctly (p. 212).
- The “Memory Stick” data is corrupted (p. 126).

#### Warning indicator pertaining to the tape

Slow flashing:

- The tape is near the end.
- No cassette is inserted.\*
- The write-protect tab on the cassette is exposed (red) (p. 23).\*

Fast flashing:

- The cassette has run out of the tape.\*

#### You need to eject the cassette\*

Slow flashing:

- The write-protect tab on the cassette is exposed (red) (p. 23).

Fast flashing:

- Moisture condensation has occurred (p. 236).
- The cassette has run out of the tape.
- The self-diagnosis display function is activated (p. 225).

#### The image is protected\*

Slow flashing:

- The image is protected (p. 176).

#### Warning indicator pertaining to the flash

Slow flashing:

- During charging

Fast flashing:

- The self-diagnosis display function is activated (p. 225).\*
- There is something wrong with the built-in flash or the external flash (optional).





















#### Warning indicator pertaining to recording

Slow flashing:

- The still image cannot be recorded on a tape or the “Memory Stick” (p. 46, 52)

\* You hear the melody or beep.

### Warning messages













- CLOCK SET Set the date and time (p. 20).
- FOR "InfoLITHIUM" BATTERY ONLY Use an "InfoLITHIUM" battery pack (p. 18).
-  CLEANING CASSETTE\*\* The video heads are dirty (p. 237).
-  FULL The cassette memory is full.\*
-  16BIT AUDIO MODE is set to 16BIT (p. 214).\* You cannot dub new audio.
-  REC MODE REC MODE is set to LP (p. 214).\* You cannot dub new audio.
-  TAPE There is no recorded portion on the tape.\* You cannot dub new audio.
-  "i.LINK" CABLE The i.LINK cable is connected (p. 118).\* You cannot dub new audio.
-  FULL The "Memory Stick" is full (p. 139).\*
-  The write-protect switch on the "Memory Stick" is set to LOCK (p. 126).\*
-  NO FILE No still image is recorded on the "Memory Stick" (p. 166, 182).\*
-  NO MEMORY STICK No "Memory Stick" is inserted.\*
-  AUDIO ERROR You are trying to record an image with sound that cannot be recorded by your camcorder on the "Memory Stick" (p. 157).\*
-  MEMORY STICK ERROR The "Memory Stick" data is corrupted (p. 128).\*
-  FORMAT ERROR The "Memory Stick" is not recognized. Check the format (p. 145, 212).\*
-  DIRECTORY ERROR There are more than two of the same directories (p. 166).\*
-  PLAY ERROR The image cannot be played back. Reinsert the "Memory Stick," then play back the image again.
-  REC ERROR Check the input signals before retrying recording.
- COPY INHIBIT The tape contains copyright control signals for copyright protection of software (p. 229).\*
-  TAPE END The tape has reached its end.\*
-  NO TAPE Insert a cassette.\*
-  NO PRINT MARK You selected MARKED in 9PIC PRINT on the touch panel using a "Memory Stick" containing no image with a print mark. (p. 182)\*
-  NO STILL IMAGE FILE You selected MULTI in 9PIC PRINT on the touch panel using a "Memory Stick" containing no still image. (p. 182)\*
- DELETING You have pressed PHOTO during deleting all images on the "Memory Stick."\*\*
- FORMATTING You have pressed PHOTO during formatting a "Memory Stick."\*\*
-  NOW CHARGING Charging an external flash (optional) does not work correctly.\*

\* You hear the melody or beep.

\*\*The  indicator and "  CLEANING CASSETTE" message appear one after another on the screen.

# Usable cassettes

## Selecting cassette types

You can use  mini DV cassettes only\*. You cannot use any other  8 mm,  Hi8,  Digital8,  VHS,  VHSC,  S-VHS,  S-VHSC,  Betamax,  ED Beta,  ED Betamax,  DV or  MICRO MV cassette.

\* There are two types of mini DV cassettes: with cassette memory and without cassette memory. Cassettes with cassette memory have the  (Cassette Memory) mark. We recommend that you use cassette with cassette memory.



IC memory is mounted on this type of cassette. Your camcorder can read and write data such as dates of recording or titles, etc. to this memory. The functions using the cassette memory require successive signals recorded on the tape. If the tape has a blank portion at the beginning or between recorded portions, titles may not be displayed properly or the search functions may not work properly. Perform the following to prevent a blank portion from being made on the tape. Press END SCH to go to the end of the recorded portion before you begin the next recording if you operate the following:

- You have ejected the cassette while recording.
- You have played back the tape.
- You have used the edit search.

If there is a blank portion or discontinuous signal on your tape, re-record from the beginning to the end of the tape as described above. The same result may occur when you record using a digital video camera recorder without a cassette memory on a tape recorded by one with the cassette memory.

---

### 4K mark on the cassette

The memory capacity of cassettes marked with  4K is 4Kbit. Your camcorder can accommodate tapes having a memory capacity of up to 16Kbit. 16Kbit cassettes are marked with  16K.

 This is the mini DV mark.

 This is the Cassette Memory mark.

These are trademarks.

## Usable cassettes

### Copyright signal

#### When you play back

Using any other video camera recorder, you cannot record on tape that has recorded copyright control signals for copyright protection of software which is played back on your camcorder.

#### When you record

You cannot record software on your camcorder that contains copyright control signals for copyright protection of software.

“COPY INHIBIT” appears on the screen or on the TV screen if you try to record such software.

Your camcorder does not record copyright control signals on the tape when it records.

### Audio mode

12-bit mode: The original sound can be recorded in stereo 1, and the new sound in stereo 2 in 32 kHz. The balance between stereo 1 and stereo 2 can be adjusted by selecting AUDIO MIX in the menu settings during playback. Both sounds can be played back.

16-bit mode: New audio cannot be recorded but the original sound can be recorded in high quality. Moreover, your camcorder can also play back sound recorded in 32 kHz, 44.1 kHz or 48 kHz. When playing back a tape recorded in the 16-bit mode, the 16BIT indicator appears on screen.

### When you play back a dual sound track tape

When you play back a dual sound track tape recorded in a stereo system, set HiFi SOUND to the desired mode in the menu settings (p. 210).

#### Sound from speaker

HiFi Sound mode	Playing back a stereo tape	Playing back a dual sound track tape
STEREO	Stereo	Main sound and sub sound
1	Left sound	Main sound
2	Right sound	Sub sound

You cannot record dual sound programs on your camcorder.

## Usable cassettes

### Notes on the cassette

#### When affixing a label on the cassette

Be sure to affix a label only at the locations illustrated below [a] to prevent malfunction of your camcorder.

#### After using the cassette

Rewind the tape to the beginning, put the cassette in its case, and store it upright.

#### When the cassette memory does not work

Reinsert a cassette. The gold-plated connector of the cassette may be dirty or dusty.

#### Cleaning the gold-plated connector

If the gold-plated connector on the cassette is dirty or dusty, the remaining tape indicator is sometimes not displayed correctly, and you may not be able to operate functions using cassette memory. Clean the gold-plated connector with a cotton-wool swab, about every 10 times that the cassette is ejected. [b]

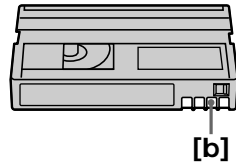
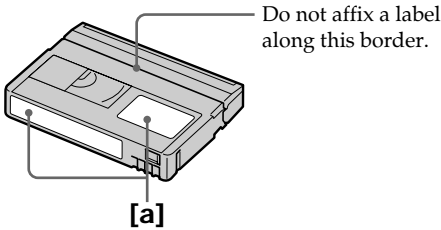

# About the “InfoLITHIUM” battery pack

## What is the “InfoLITHIUM” battery pack?

The “InfoLITHIUM” battery pack is a lithium-ion battery pack that has functions for communicating information related to operating conditions between the battery pack and an optional AC adaptor/charger.

The “InfoLITHIUM” battery pack calculates the power consumption according to the operating conditions of your camcorder, and displays the remaining battery time in minutes.

With an AC adaptor/charger (optional), the remaining battery time and charging time are displayed.

## Charging the battery pack

- Be sure to charge the battery pack before you start using your camcorder.
- We recommend charging the battery pack in an ambient temperature of between 10°C to 30°C (50°F to 86°F) until FULL appears in the display window, indicating that the battery pack is fully charged. If you charge the battery outside of this temperature range, you may not be able to efficiently charge the battery pack.
- After charging is completed, either disconnect the cable from the DC IN jack on your camcorder or remove the battery pack.

## Effective use of the battery pack

- Battery pack performance decreases in low-temperature surroundings. So, the time that the battery pack can be used becomes shorter. We recommend the following to ensure longer battery pack use:
  - Put the battery pack in a pocket to warm it up, and insert it in your camcorder immediately before you start taking shots.
  - Use the large-capacity battery pack (NP-FM70/QM71/FM90/FM91/QM91, optional).
- Frequently using the LCD panel or frequently operating playback, fast forward or rewind wears out the battery pack faster. We recommend using the large-capacity battery pack (NP-FM70/QM71/FM90/FM91/QM91, optional).
- Be sure to turn the POWER switch to OFF (CHG) when not taking shots or playing back on your camcorder. The battery pack is also consumed when your camcorder is in the standby or playback pause.
- Have spare battery packs handy for two or three times the expected recording time, and make trial recordings before taking the actual recording.
- Do not expose the battery pack to water. The battery pack is not water-resistant.

## Remaining battery time indicator

- If the power goes off although the remaining battery time indicator indicates that the battery pack has enough power to operate, fully charge the battery pack again so that the indication on the remaining battery time indicator is correct. Note, however, that the correct battery indication sometimes will not be restored if it is used in high temperatures for a long time or left in a fully charged state, or the battery pack is frequently used. Regard the remaining battery time indication as the approximate recording time.
- The  mark indicating that there is little remaining battery time sometimes flashes depending on the operating conditions or ambient temperature and environment even if the remaining battery time is about five to ten minutes.

## About the “InfoLITHIUM” battery pack

---

### How to store the battery pack

- If the battery pack is not used for a long time, do the following procedure once per year to maintain proper function.
  1. Fully charge the battery.
  2. Discharge on your electronic equipment.
  3. Remove the battery from the equipment and store it in a dry, cool place.
- To use the battery pack up on your camcorder, leave your camcorder in the recording standby until the power goes off without a cassette inserted.

### Battery life

- The battery life is limited. Battery capacity drops little by little as you use it more and more, and as time passes. When the available battery time is shortened considerably, a probable cause is that the battery pack has reached the end of its life. Buy a new battery pack.
- The battery life varies according to how it is stored and operating conditions and environment for each battery pack.



# About i.LINK

The DV Interface on this unit is an i.LINK-compliant DV input/output Interface. This section describes the i.LINK standard and its features.

## What is i.LINK?

i.LINK is a digital serial interface for handling digital video, digital audio and other data in two directions between equipment having the i.LINK jack, and for controlling other equipment.

i.LINK-compatible equipment can be connected by a single i.LINK cable. Possible applications are operations and data transactions with various digital AV equipment. When two or more i.LINK-compatible equipment are connected to this unit in a daisy chain, operations and data transactions are possible with not only the equipment that this unit is connected to but also with other devices via the directly connected equipment.

Note, however, that the method of operation sometimes varies according to the characteristics and specifications of the equipment to be connected, and that operations and data transactions are sometimes not possible on some connected equipment.

---

### Note

Normally, only one piece of equipment can be connected to this unit by the i.LINK cable. When connecting this unit to i.LINK-compatible equipment having two or more i.LINK jacks (DV jacks), refer to the operating instructions of the equipment to be connected.

## About the name “i.LINK”

i.LINK is a more familiar term for IEEE 1394 data transport bus proposed by SONY, and is a trademark approved by many corporations. IEEE 1394 is an international standard standardized by the Institute of Electrical and Electronic Engineers.

## i.LINK baud rate

i.LINK's maximum baud rate varies according to the equipment. Three maximum baud rates are defined:

- S100 (approx. 100Mbps\*)
- S200 (approx. 200Mbps)
- S400 (approx. 400Mbps)

The baud rate is listed under “Specifications” in the operating instructions of each equipment. It is also indicated near the i.LINK jack on some equipment. The maximum baud rate of equipment on which it is not indicated such as this unit is “S100”.

When units are connected to equipment having a different maximum baud rate, the baud rate sometimes differs from the indicated baud rate.

### \*What is Mbps?

Mbps stands for megabits per second, or the amount of data that can be sent or received in one second. For example, a baud rate of 100Mbps means that 100 megabits of data can be sent in one second.

## About i.LINK

---

### i.LINK functions on this unit

For details on how to dub when this unit is connected to other video equipment having DV Interface, see page 97 and 111.

This unit can also be connected to other i.LINK (DV Interface) compatible equipment made by SONY (e.g. VAIO series personal computer) other than video equipment. Before connecting this unit to a personal computer, make sure that application software supported by this unit is already installed on the personal computer.

For details on precautions when connecting this unit, also refer to the operating instructions of the equipment to be connected.

### Required i.LINK cable

Use the Sony i.LINK 4-pin-to-4-pin cable (during DV dubbing).

i.LINK and  are trademarks.

# Using your camcorder abroad

## Using your camcorder abroad

Countries and areas where you can use network functions are restricted. For details, refer to the separate Network Operating Instructions. (DCR-TRV950 only)

You can use your camcorder in any country or area with the AC power adaptor supplied with your camcorder within 100 V to 240 V AC, 50/60 Hz.

When charging the battery pack, use a commercially available AC plug adaptor [a], if necessary, depending on the design of the wall outlet [b].

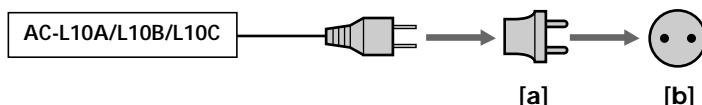

Your camcorder is an NTSC system based camcorder. If you want to view the playback picture on a TV, it must be an NTSC system based TV with the AUDIO/VIDEO input jack.

The following shows TV color systems used overseas.

### NTSC system

Bahama Islands, Bolivia, Canada, Central America, Chile, Colombia, Ecuador, Guyana, Jamaica, Japan, Korea, Mexico, Peru, Surinam, Taiwan, the Philippines, the U.S.A., Venezuela, etc.

### PAL system

Australia, Austria, Belgium, China, Czech Republic, Denmark, Finland, Germany, Holland, Hong Kong, Hungary, Italy, Kuwait, Malaysia, New Zealand, Norway, Poland, Portugal, Singapore, Slovak Republic, Spain, Sweden, Switzerland, Thailand, United Kingdom etc.

### PAL-M system

Brazil

### PAL-N system

Argentina, Paraguay, Uruguay



### SECAM system

Bulgaria, France, Guiana, Iran, Iraq, Monaco, Russia, Ukraine, etc.

# Maintenance information and precautions

---

## Moisture condensation

If your camcorder is brought directly from a cold place to a warm place, moisture may condense inside your camcorder, on the surface of the tape, or on the lens. In this state, the tape may stick to the head drum and be damaged or your camcorder may not operate correctly. If there is moisture inside your camcorder, the beep and the  indicator flashes. When the  indicator flashes at the same time, the cassette is inserted in your camcorder. If moisture condenses on the lens, the indicator will not appear.

### If moisture condensation has occurred

None of the functions except cassette ejection will work. Eject the cassette, turn off your camcorder, and leave it for about one hour with the cassette lid open. Your camcorder can be used again if the  indicator does not appear when the power is turned on again.

If moisture starts to condense, your camcorder sometimes cannot detect condensation. If this happens, the cassette is sometimes not ejected for 10 seconds after the cassette lid is opened. This is not a malfunction. Do not close the cassette lid until the cassette is ejected.

---

### Note on moisture condensation

Moisture may condense when you bring your camcorder from a cold place into a warm place (or vice versa) or when you use your camcorder in a hot place as follows:

- You bring your camcorder from a ski slope into a place warmed up by heating device.
- You bring your camcorder from an air-conditioned car or room into a hot place outside.
- You use your camcorder after a squall or a shower.
- You use your camcorder in a high temperature and humidity place.



### How to prevent moisture condensation

When you bring your camcorder from a cold place into a warm place, put your camcorder in a plastic bag and tightly seal it. Remove the bag when the air temperature inside the plastic bag has reached the surrounding temperature (after about one hour).

### Maintenance information

#### Cleaning the video heads

To ensure normal recording and clear pictures, clean the video heads. The video heads may be dirty when:

- Mosaic-pattern noise appears on the playback picture.
- Playback pictures do not move.
- Playback pictures do not appear.
- The  indicator and “ CLEANING CASSETTE” message appear one after another, or the  indicator flashes on the screen during recording.

If the above problem [a], [b] or [c] occurs, clean the video heads for 10 seconds with the Sony DVM-12CLD cleaning cassette (optional). Check the picture and if the above problem persists, repeat cleaning.

[a]



[b]



[c]



If the video heads get dirtier, the entire screen becomes blue [c].

#### Cleaning the LCD screen

If fingerprints or dust make the LCD screen dirty, we recommend using the Cleaning cloth (supplied) to clean the LCD screen. When you use the LCD Cleaning Kit (optional), do not apply the cleaning liquid directly to the LCD screen. Clean the LCD screen with cleaning paper moistened with the liquid.

### Adjusting the LCD screen (CALIBRATION)

The buttons on the touch panel may not work correctly. If this happens, follow the procedure below.

- (1) Set the POWER switch to OFF (CHG).
- (2) Eject the cassette from your camcorder, then disconnect any connecting cable from your camcorder.
- (3) Set the POWER switch to VCR while pressing DISPLAY/TOUCH PANEL on your camcorder, then keep pressing DISPLAY/TOUCH PANEL for about five seconds.
- (4) Follow the procedure below using an object such as the corner of a "Memory Stick" supplied with your camcorder.  
You can use the supplied stylus for this operation (DCR-TRV950 only).
  - ① Touch ✕ at the upper left corner.
  - ② Touch ✕ at the lower right corner.
  - ③ Touch ✕ in the middle of the screen.

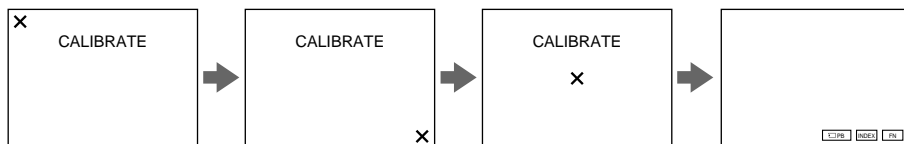

#### Note

If you do not press the right spot, ✕ always returns to the position at the upper left corner. In this case, start from step 4 again.

### Charging the built-in rechargeable battery

Your camcorder has a built-in rechargeable battery so that the date, time and other settings are retained even when the POWER switch is turned off. The built-in rechargeable battery is always charged as long as you are using your camcorder. The battery, however, will become discharged gradually if you do not use your camcorder. It will be completely discharged in **about four months** if you do not use your camcorder at all. Even if the built-in rechargeable battery is not charged, it will not affect camcorder operation. To retain the date, time, and other information, charge the battery if the battery is discharged.

#### Charging the built-in rechargeable battery:

- Connect your camcorder to house current using the AC power adaptor supplied with your camcorder, and leave your camcorder with the POWER switch turned off for more than 24 hours.
- Or, install a charged battery pack in your camcorder, and leave your camcorder with the POWER switch set to OFF (CHG) for more than 24 hours.

### Precautions

#### Camcorder operation

- Operate your camcorder on 7.2 V (battery pack) or 8.4 V (AC power adaptor).
- For DC or AC operation, use the accessories recommended in these operating instructions.
- If any solid object or liquid gets inside the casing, unplug your camcorder and have it checked by a Sony dealer before operating it any further.
- Avoid rough handling or mechanical shock. Be particularly careful of the lens.
- Keep the POWER switch set to OFF (CHG) when you are not using your camcorder.
- Do not wrap your camcorder with a towel, for example, and operate it. Doing so might cause heat to build up inside.
- Keep your camcorder away from strong magnetic fields or mechanical vibration.
- Do not press the LCD screen with a sharp-pointed object other than the supplied stylus (DCR-TRV950 only).
- If your camcorder is used in a cold place, a residual image may appear on the LCD screen. This is not a malfunction.
- While using your camcorder, the back of the LCD screen may heat up. This is not a malfunction.

#### On handling tapes

- Do not insert anything into the small holes on the rear of the cassette. These holes are used to sense the type and thickness of the tape and if the recording tab is in or out.
- Do not open the cassette protect cover or touch the tape.
- Avoid touching or damaging the terminals. To remove dust, clean the terminals with a soft cloth.

## Maintenance information and precautions

---

### Camcorder care

- Remove the cassette, and periodically turn on the power, operate the CAMERA and VCR sections and play back a tape for about three minutes when your camcorder is not to be used for a long time.
- Clean the lens with a soft brush to remove dust. If there are fingerprints on the lens, remove them with a soft cloth.
- Clean the camcorder body with a dry soft cloth, or a soft cloth lightly moistened with a mild detergent solution. Do not use any type of solvent which may damage the finish.
- Do not let sand get into your camcorder. When you use your camcorder on a sandy beach or in a dusty place, protect it from the sand or dust. Sand or dust may cause your camcorder to malfunction, and sometimes this malfunction cannot be repaired.

### AC power adaptor

- Unplug the unit from the wall outlet when you are not using it for a long time. To disconnect the power cord, pull it out by the plug. Never pull the power cord itself.
- Do not operate the unit with a damaged cord or if the unit has been dropped or damaged.
- Do not bend the power cord forcibly, or place a heavy object on it. This will damage the cord and may cause fire or electric shock.
- Prevent metallic objects from coming into contact with the metal parts of the connecting section. If this happens, a short may occur and the unit may be damaged.
- Always keep metal contacts clean.
- Do not disassemble the unit.
- Do not apply mechanical shock or drop the unit.
- While the unit is in use, particularly during charging, keep it away from AM receivers and video equipment. AM receivers and video equipment disturb AM reception and video operation.
- The unit becomes warm during use. This is not a malfunction.
- Do not place the unit in locations that are:
  - Extremely hot or cold
  - Dusty or dirty
  - Very humid
  - Vibrating

### About care and storage of the lens

- Wipe the surface of the lens clean with a soft cloth in the following instances:
  - When there are fingerprints on the lens surface.
  - In hot or humid locations.
  - When the lens is used in environments such as the seaside.
- Store the lens in a well-ventilated location subject to little dirt or dust.

To prevent mold from growing, periodically perform the above.

We recommend turning on and operating the video camera recorder about once per month to keep the video camera recorder in an optimum state for a long time.



## Maintenance information and precautions

---

### Battery pack

- Use only the specified charger or video equipment with the charging function.
- To prevent accident from a short circuit, do not allow metal objects to come into contact with the battery terminals.
- Keep the battery pack away from fire.
- Never expose the battery pack to temperatures above 60°C (140°F), such as in a car parked in the sun or under direct sunlight.
- Keep the battery pack dry.
- Do not expose the battery pack to any mechanical shock.
- Do not disassemble nor modify the battery pack.
- Attach the battery pack to the video equipment securely.
- Charging while some capacity remains does not affect the original battery capacity.

### Notes on dry batteries

- To avoid possible damage from battery leakage or corrosion, observe the following:
- Be sure to insert the batteries with the + and – correctly matching the + and – inside the battery compartment.
  - Dry batteries are not rechargeable.
  - Do not use a combination of new and old batteries.
  - Do not use different types of batteries.
  - Current flows from batteries when you are not using them for a long time.
  - Do not use leaking batteries.

### If batteries are leaking

- Wipe off the liquid in the battery compartment carefully before replacing the batteries.
- If you touch the liquid, wash it off with water.
- If the liquid gets into your eyes, wash your eyes with a lot of water and then consult a doctor.

If any problem occurs, unplug your camcorder and contact your nearest Sony dealer.

# Specifications

## Video camera recorder

### System

#### Video recording system

2 rotary heads

Helical scanning system

#### Audio recording system

Rotary heads, PCM system

Quantization: 12 bits (Fs 32 kHz,

stereo 1, stereo 2), 16 bits

(Fs 48 kHz, stereo)

#### Video signal

NTSC color, EIA standards

#### Usable cassette

Mini DV cassette with the  mark printed

#### Tape speed

SP: Approx. 18.81 mm/s

LP: Approx. 12.56 mm/s

#### Recording/playback time (using cassette DVM60)

SP: 1 hour

LP: 1.5 hours

#### Fastforward/rewind time (using cassette DVM60)

When using the battery pack:

Approx. 2 min. and 30 seconds

When using the AC power

adaptor:

Approx. 1 min. and 45 seconds

#### Viewfinder

Electric viewfinder (color)

#### Image device

3.8 mm (1/4.7 type) 3 CCD

(Charge Coupled Device)

Gross: Approx. 1 070 000 pixels

Effective (still):

Approx. 1 000 000 pixels

Effective (moving):

Approx. 690 000 pixels

#### Lens

Combined power zoom lens

Filter diameter: 37 mm

(1 1/2 in.)

12× (Optical), 150× (Digital)

F 1.6 – 2.8

#### Focal length

3.6 – 43.2 mm (5/32 – 1 3/4 in.)

When converted to a 35 mm still camera

In CAMERA



49 – 588 mm (1 15/16 – 23 1/4 in.)

In MEMORY

41 – 492 mm (1 5/8 – 19 3/8 in.)

#### Color temperature

Auto,  Indoor (3 200 K),

 Outdoor (5 800 K), 

#### Minimum illumination

7 lx (lux) (F 1.6)

### Input/Output connectors

#### S video input/output

4-pin mini DIN

Luminance signal: 1 Vp-p,

75 Ω (ohms), unbalanced

Chrominance signal: 0.286 Vp-p,

75 Ω (ohms), unbalanced

#### Audio/Video input/output

AV MINI JACK, 1 Vp-p,

75 Ω (ohms), unbalanced, sync negative

327 mV, (at output impedance more than 47 kΩ (kilohms))

Output impedance with less than 2.2 kΩ (kilohms)/Stereo minijack (ø 3.5 mm)

Input impedance more than 47 kΩ (kilohms)

#### DV input/output

4-pin connector

#### Headphone jack

Stereo minijack (ø 3.5 mm)

#### LANC jack

Stereo mini-minijack (ø 2.5 mm)

#### USB jack

mini-B

#### MIC jack

Minijack, 0.388 mV low impedance with 2.5 to 3.0 V DC, output impedance 6.8 kΩ (kilohms) (ø 3.5 mm)

Stereo type

### LCD screen

#### Picture

8.8 cm (3.5 type)

72.2 × 50.4 mm (2 7/8 × 2 in.)

#### Total dot number

246 400 (1 120 × 220)

### Wireless communications

#### (DCR-TRV950 only)

#### Communications system

Bluetooth standard Ver.1.1

**Max. baud rate**<sup>1)2)</sup>

Approx. 723 kbps

#### Output

Bluetooth standard Power Class 2

#### Communications distance<sup>2)</sup>

Max. wireless distance

Approx. 10 m (393 3/4 in.) (When

connecting to BTA-NW1/NW1A)

#### Compatible Bluetooth profile<sup>3)</sup>

Generic Access Profile

Dial-up Networking Profile

#### Operating frequency band

2.4 GHz band (2.400 GHz – 2.483 5 GHz)

- 1) Max. baud rate of Bluetooth standard Ver.1.1
- 2) Varies according to the distance between communicating devices, presence of obstacles, radiowave conditions, and other factors.
- 3) This is a specification matched to specific usage requirements between Bluetooth compatible devices. It is laid down in the Bluetooth standards.

# Specifications

## General

### Power requirements

7.2 V (battery pack)

8.4 V (AC power adaptor)

### Average power consumption (when using the battery pack)

During camera recording using LCD

6.3 W

Viewfinder

4.9 W

### Operating temperature

0°C to 40°C (32°F to 104°F)

### Storage temperature

-20°C to +60°C

(-4°F to +140°F)

### Dimensions (Approx.)

93 × 99 × 202 mm

(3 3/4 × 4 × 8 in.) (w/h/d)

### Mass (Approx.)

DCR-TRV950: 970 g (2 lb 2 oz)

DCR-TRV940: 960 g (2 lb 1 oz)

main unit only

DCR-TRV950: 1.1kg (2 lb 6 oz)

DCR-TRV940: 1.1kg (2 lb 6 oz)

including the battery pack

NP-FM50, cassette DVM60 and

lens cap, Shoulder strap

### Supplied accessories

See page 14.

## AC power adaptor

### Power requirements

100 – 240 V AC, 50/60 Hz

### Power consumption

23 W

### Output voltage

DC OUT: 8.4 V, 1.5 A in the operating mode

### Operating temperature

0°C to 40°C (32°F to 104°F)

### Storage temperature

-20°C to +60°C

(-4°F to +140°F)

### Dimensions (approx.)

125 × 39 × 62 mm

(5 × 1 9/16 × 2 1/2 in.) (w/h/d)

excluding projecting parts

### Mass (approx.)

280 g (9.8 oz)

excluding power cord

## Battery pack

### Maximum output voltage

DC 8.4 V

### Output voltage

DC 7.2 V

### Capacity

8.5 Wh (1 180 mAh)

### Dimensions (approx.)

38.2 × 20.5 × 55.6 mm

(1 9/16 × 13/16 × 2 1/4 in.)

(w/h/d)

### Mass (approx.)

76 g (2.7 oz)

### Type

Lithium ion

## “Memory Stick”

### Memory

Flash memory

8MB: MSA-8A

### Operating voltage

2.7 – 3.6 V

### Power consumption

Approx. 45 mA in the operating mode

Approx. 130 µA in the standby mode

### Dimensions (approx.)

50 × 2.8 × 21.5 mm

(2 × 1/8 × 7/8 in.) (w/h/d)

### Mass (approx.)

4 g (0.14 oz)

Design and specifications are subject to change without notice.

# Identifying parts and controls

## Camcorder

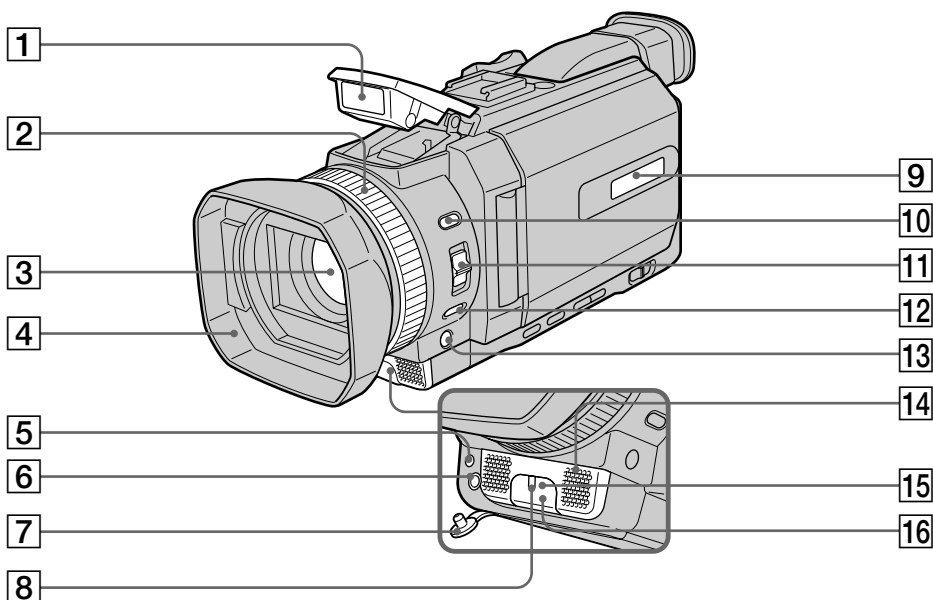

- |  |  |
|--|--|
| <b>1</b> Flash (p. 48, 139)  | <b>8</b> Camera recording lamp (p. 26)         |
| <b>2</b> Focus ring (p. 76)  | <b>9</b> Display window (p. 16)                |
| <b>3</b> Lens  | <b>10</b> <b>⚡</b> (flash) button (p. 48, 139) |
| <b>4</b> Lens hood   | <b>11</b> FOCUS switch (p. 76)                 |
| <b>5</b> HOLOGRAM AF emitter (p. 141)  | <b>12</b> PUSH AUTO button (p. 76)             |
| <b>6</b> MIC jack (PLUG IN POWER) (red)<br>Connect an external microphone (optional). This jack also accepts a "plug-in-power" microphone. | <b>13</b> FADER button * (p. 56)               |
| <b>7</b> MIC jack cover  | <b>14</b> Microphone                           |
|  | <b>15</b> Infrared rays emitter (p. 101)       |
|  | <b>16</b> Remote sensor                        |

\* The FADER button has a tactile dot for easy operation.

### Removing the lens hood

To remove the lens hood to attach the optional wide teleconversion lens filter, etc., unscrew the lens hood counterclockwise. To attach the lens hood again, fit the protrusions on the lens hood into the holes of the lens and screw the lens hood clockwise.

### When using additional filters

Shading may occur on the recorded image due to the lens hood.

## Identifying parts and controls

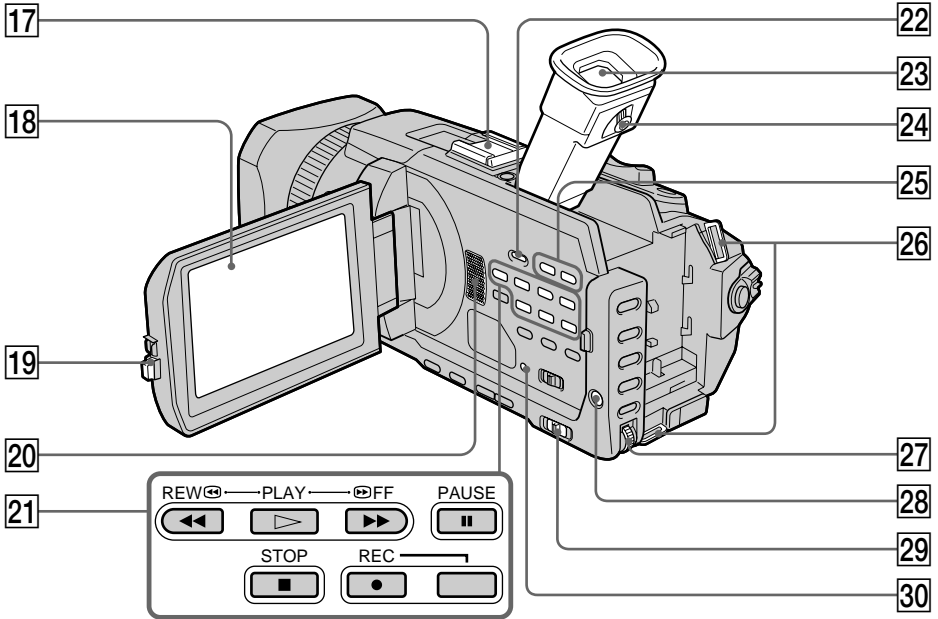

- |  |  |
|--|--|
| <b>17</b> Intelligent accessory shoe (p. 115, 181) | <b>24</b> Viewfinder lens adjustment lever (p. 30) |
| <b>18</b> LCD/Touch panel screen (p. 24, 129)      | <b>25</b> VOLUME buttons ** (p. 39)                |
| <b>19</b> OPEN button                              | <b>26</b> Hooks for shoulder strap                 |
| <b>20</b> Speaker                                  | <b>27</b> SEL/PUSH EXEC dial                       |
| <b>21</b> Video control buttons *                  | <b>28</b> MENU button (p. 207)                     |
| <b>22</b> DISPLAY/TOUCH PANEL button (p. 41)       | <b>29</b> AUTO LOCK selector (p. 67)               |
| <b>23</b> Viewfinder (p. 30)                       | <b>30</b> RESET button (p. 224)                    |

\* The PLAY button of the Video control buttons has a raised tactile dot for easy operation.

\*\* The + side of VOLUME buttons has a raised tactile dot for easy operation.

### Intelligent Accessory Shoe

#### Notes on the intelligent accessory shoe

- The intelligent accessory shoe supplies power to optional accessories such as a video light or microphone.
- The intelligent accessory shoe is linked to the POWER switch, allowing you to turn the power supplied by the shoe on and off. Refer to the operating instructions of the accessory for further information.
- The intelligent accessory shoe has a safety device for fixing the installed accessory securely. To connect an accessory, press down and push it to the end, and then tighten the screw.
- To remove an accessory, loosen the screw, and then press down and pull out the accessory.

## Identifying parts and controls

---

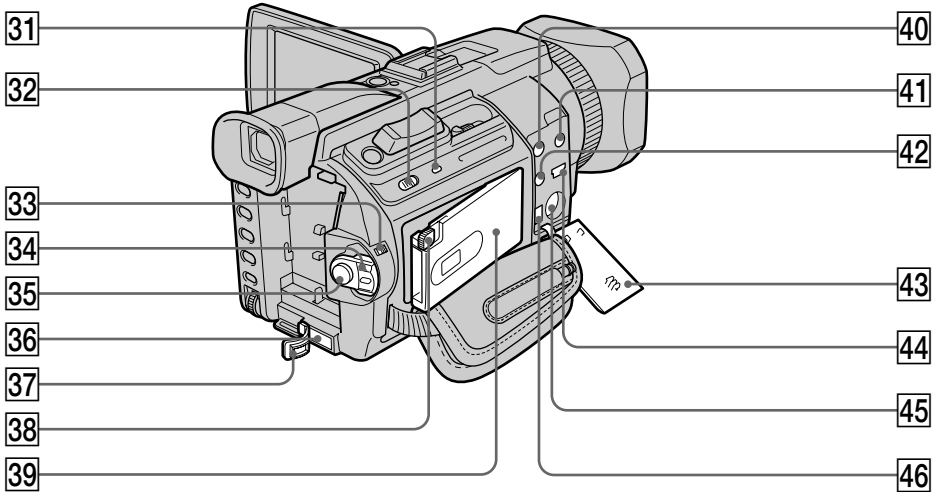

- |   |  |
|---|--|
| <b>31</b> Access lamp                         | <b>40</b> <b>AUDIO/VIDEO ID-2 jack (yellow)</b> (p. 45, 95, 146, 158, 204) |
| <b>32</b> <b>MEMORY OPEN button</b> (p. 128)  | <b>41</b> <b>(headphones) jack (green)</b>                                 |
| <b>33</b> <b>LOCK switch</b> (p. 26)          | When you use headphones, the speaker on your camcorder is silent.          |
| <b>34</b> <b>POWER switch</b>                 | <b>42</b> <b>(LANC) jack (blue)</b>  |
| <b>35</b> <b>START/STOP button</b> (p. 26)    | <b>43</b> <b>Jack cover</b> (p. 45)  |
| <b>36</b> <b>DC IN jack</b> (p. 19)           | <b>44</b> <b>(USB) jack</b> (p. 183)                                       |
| <b>37</b> <b>DC IN jack cover</b>             | <b>45</b> <b>S VIDEO ID-2 jack</b> (p. 45, 95, 146, 158)                   |
| <b>38</b> <b>MEMORY EJECT button</b> (p. 128) | <b>46</b> <b>DV Interface</b> (p. 97, 111, 147, 159, 204)                  |
| <b>39</b> <b>"Memory Stick" slot</b> (p. 128) |  |

---

### **(LANC)** LANC

The **(LANC)** LANC stands for Local Application Control Bus System. The **(LANC)** LANC control jack is used for controlling the tape transport of video equipment and peripherals connected to it. This jack has the same function as the jack indicated as CONTROL L or REMOTE.

## Identifying parts and controls

---

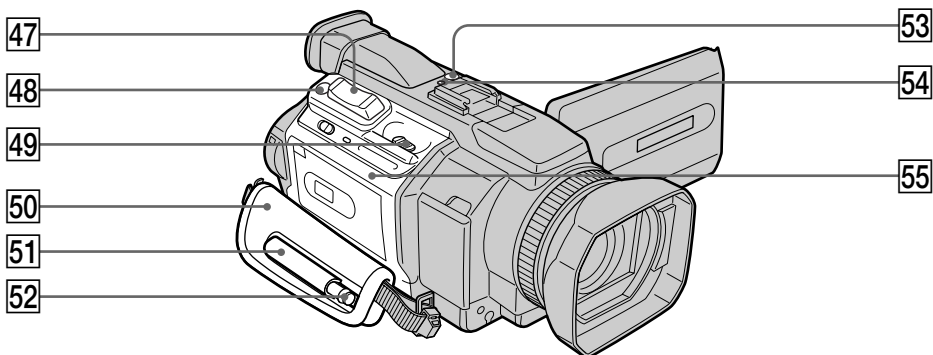

**47** Power zoom lever (p. 31, 86, 173)

**48** PHOTO button (p. 46, 51, 135)

**49**  $\square$  OPEN/  $\blacktriangle$  EJECT lever (p. 23)

**50** Grip strap

**51** Holder (DCR-TRV950 only)

**52** Stylus (p. 206) (DCR-TRV950 only)

**53** NETWORK button (p. 205)  
(DCR-TRV950 only)

**54**  $\text{Bluetooth}$  lamp (p. 205)  
(DCR-TRV950 only)

**55** Cassette lid

---

### Fastening the grip strap

Fasten the grip strap firmly.

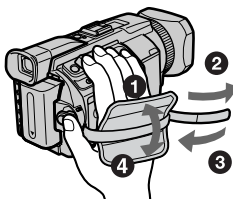

## Identifying parts and controls

---

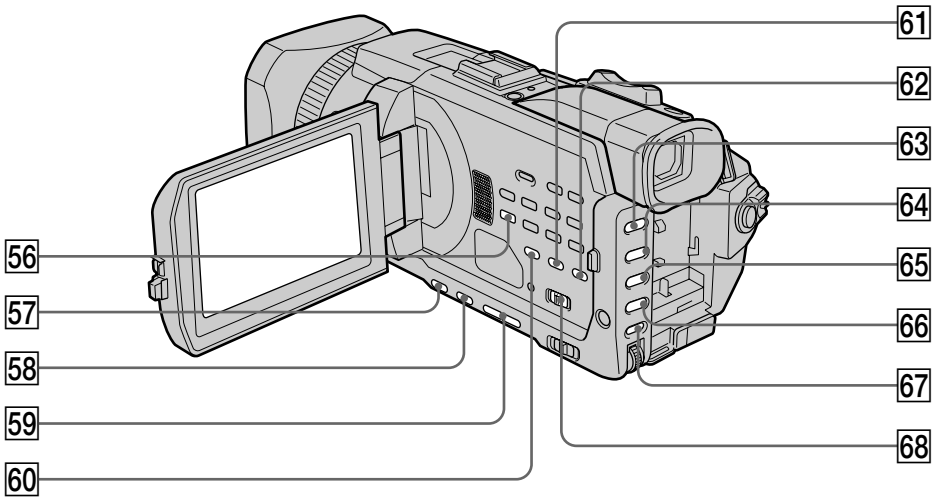

**56** AUDIO DUB button (p. 117)

**57** BACK LIGHT button (p. 34)

**58** SPOT LIGHT button \* (p. 35)

**59** EDITSEARCH button \* (p. 37)

**60** DATA CODE button (p. 41)

**61** COLOR BAR button (p. 66)

**62** CUSTOM PRESET button (p. 62)

**63** PROGRAM AE button (p. 68)

**64** SHUTTER SPEED button \* (p. 70)

**65** WHT BAL button (p. 72)

**66** EXPOSURE button (p. 74)

**67** AUDIO LEVEL button (p. 79)

**68** ZEBRA selector (p. 65)

\* Each of the buttons has a raised tactile dot. (The EDIT SEARCH button has it on the –  side.)  
Use it for easy operation.



## Identifying parts and controls

---

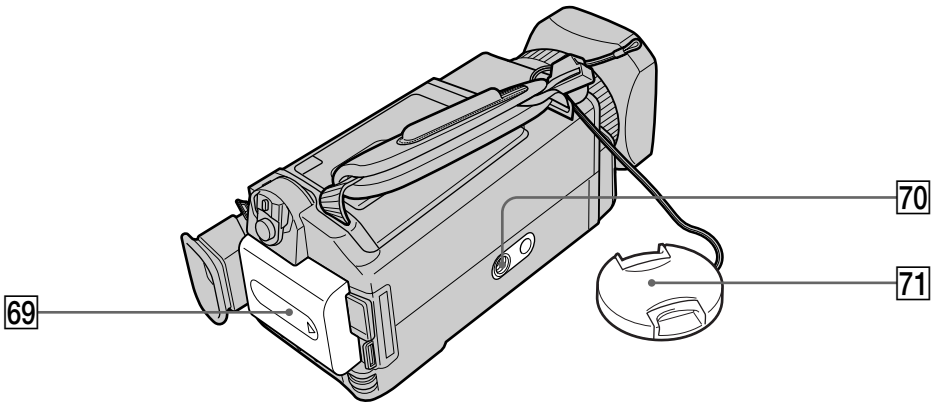

**69** Battery Pack (p. 15)

**70** Tripod receptacle

Make sure that the length of the tripod screw is less than 5.5 mm (7/32 inch). Otherwise, you cannot attach the tripod securely, and the screw may damage your camcorder.

**71** Lens cap (p. 26)

## Identifying parts and controls

### Remote Commander

The buttons that have the same name on the Remote Commander as on your camcorder function identically to the buttons on your camcorder.

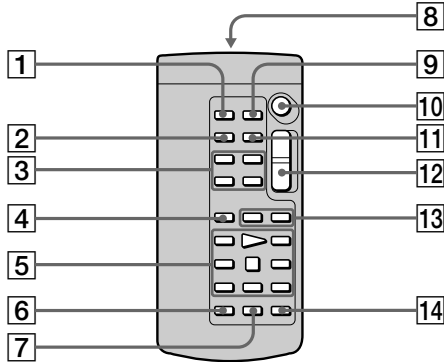

- 1 PHOTO button (p. 46, 51, 135)
- 2 DISPLAY button (p. 41)
- 3 Memory control buttons
- 4 SEARCH MODE button (p. 89, 90, 92)
- 5 Video control buttons (p. 43)
- 6 REC button
- 7 MARK button (p. 106, 160)

- 8 Transmitter  
Point toward the remote sensor to control your camcorder after turning on your camcorder.
- 9 ZERO SET MEMORY button (p. 88)
- 10 START/STOP button (p. 26)
- 11 DATA CODE button (p. 41)
- 12 Power zoom button (p. 31)
- 13 ◀◀/▶▶ buttons (p. 89, 90, 92)
- 14 AUDIO DUB button (p. 117)

## Identifying parts and controls

---

### To prepare the Remote Commander

Insert two size AA (R6) batteries by matching the + and – on the batteries to the + and – in the battery compartment.

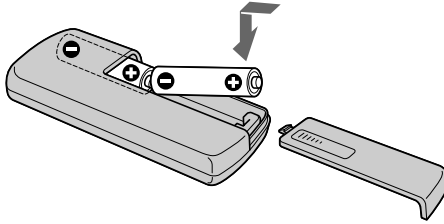

---

### Notes on the Remote Commander

- Point the remote sensor away from strong light sources such as direct sunlight or overhead lighting. Otherwise, the Remote Commander may not function properly.
- Your camcorder works in the commander mode VTR 2. Commander modes 1, 2 and 3 are used to distinguish your camcorder from other Sony VCRs to avoid erroneous remote control operation. If you use another Sony VCR in the commander mode VTR 2, we recommend changing the commander mode or covering the sensor of the VCR with black paper.

# Identifying parts and controls

## Operation indicators

### LCD screen and Viewfinder

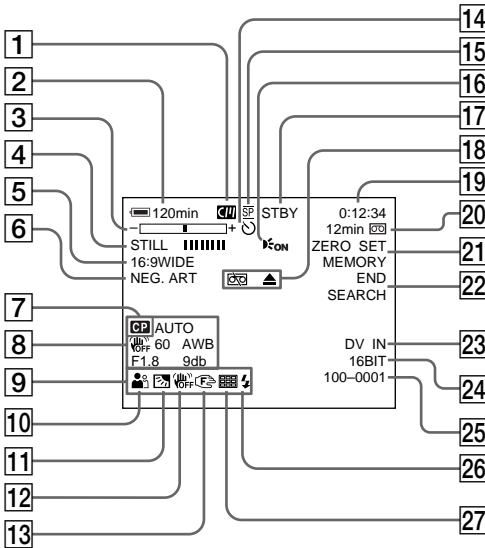

- 1 Cassette memory (p. 12, 228)
- 2 Remaining battery time (p. 33)
- 3 Zoom (p. 31)/  
Exposure (p. 74)/  
Data file name (p. 126)
- 4 Digital effect (p. 59, 85)/  
MEMORY MIX (p. 148)/  
FADER (p. 55)
- 5 16:9WIDE (p. 53)
- 6 Picture effect (p. 58, 84)
- 7 Custom preset (p. 62)
- 8 Data code (p. 41)
- 9 Volume (p. 39)/  
Date (p. 33)
- 10 PROGRAM AE (p. 67)
- 11 Backlight (p. 34)/  
Spot light (p. 35)
- 12 SteadyShot off (p. 209)
- 13 Manual focus/Infinity (p. 76)
- 14 Self-timer (p. 36, 50, 143, 155)
- 15 Recording mode (p. 27)
- 16 HOLOGRAM AF (p. 141)
- 17 STBY/REC (p. 26)/  
Video control mode (p. 43)/  
Image size (p. 133)/  
Image quality (p. 131)
- 18 Warning (p. 226)
- 19 Tape counter (p. 33)/  
Time code (p. 33)/  
Self-diagnosis (p. 225)/  
Tape photo (p. 51)/  
Memory photo (p. 46, 135)/  
Image number (p. 166)
- 20 Remaining tape (p. 33)/  
Memory playback (p. 166)
- 21 ZERO SET MEMORY (p. 88)
- 22 END SEARCH (p. 37)
- 23 A/V → DV (p. 204)/  
DV IN (p. 112)
- 24 Audio mode (p. 214)
- 25 Data file name (p. 126)/  
Time (p. 33)/  
Audio input level (p. 79)
- 26 Flash (p. 48, 139)
- 27 Continuous photo recording (p. 137)

### Display window

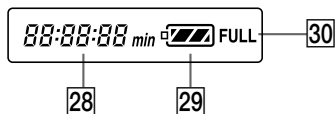

- 28** Remaining battery time indicator (p. 16)/  
Tape counter (p. 33)/  
Time code indicator (p. 33)/  
Image number (p. 166)/  
Self-diagnosis indicator (p. 225)
- 29** Remaining battery time (p. 16)
- 30** FULL charge indicator (p. 16)

# Index

---

## A, B

AC power adaptor .....	16
Adjusting viewfinder .....	30
Audio dubbing .....	115
AUDIO LEVEL .....	79
AUDIO MIX .....	210
Audio mode .....	214
AUTO LOCK selector .....	67
Auto red-eye reduction .....	48, 139
AUTO SHTR .....	208
A/V connecting cable .....	45, 95, 109, 146, 158, 204
BACK LIGHT .....	34
Battery pack .....	15
BEEP .....	216
BOUNCE .....	55

---

## C, D

CALIBRATION .....	238
Camera chromakey .....	148
Cassette memory .....	12, 228
Charging battery .....	16
Charging built-in rechargeable battery .....	239
Clock set .....	20
Color bar .....	66
Continuous photo recording .....	137
Custom preset .....	62
Data code .....	41
Date search .....	90
DEMO MODE .....	215
DIGITAL EFFECT .....	59, 85
Digital program editing .....	98, 160
Digital zoom .....	31
DISPLAY .....	41
DOT .....	55
Dual sound track tape .....	229

---

## E

EDITSEARCH .....	37
END SEARCH .....	37, 43
Exposure .....	74

---

## F, G, H

FADER .....	55
Fade in/out .....	55
Flash .....	48, 139
FLASH MOTION .....	59
Flexible Spot Meter .....	75
FOCUS .....	76
Format .....	126, 212
Frame recording .....	83
Full charge .....	16

Grip strap .....	247
Guide frame .....	64
Ⓜ (Headphone) jack .....	246
Heads .....	237
HiFi SOUND .....	210
HOLOGRAM AF .....	141

---

## I, J, K, L

i.LINK .....	233
i.LINK cable .....	97, 111, 147, 159, 204
Image protection .....	176
Image quality .....	131
Image size .....	133
Index screen .....	167
"InfoLITHIUM" battery .....	231
Infrared rays emitter .....	101
Insert editing .....	113
Intelligent accessory shoe ...	245
Interval recording .....	81
JPEG .....	126
Labeling a cassette .....	124
LANC jack .....	246
LUMINANCEKEY .....	59

---

## M, N

Main sound .....	229
Manual focus .....	76
Memory chromakey .....	148
Memory luminancekey .....	148
MEMORY MIX .....	148
Memory overlap .....	148
Memory PB ZOOM .....	173
Memory photo recording ...	135
"Memory Stick" .....	126
Menu settings .....	207
M. FADER .....	55
Mirror mode .....	32
Moisture condensation .....	236
MONOTONE .....	55
MPEG .....	126
MPEG movie recording .....	153
NETWORK .....	205
NTSC system .....	235

---

## O, P, Q

OLD MOVIE .....	59
Operation indicators .....	252
OVERLAP .....	55
Photo save .....	163
Photo scan .....	94
Photo search .....	92
PICTURE EFFECT .....	58, 84
Picture search .....	43
Playback pause .....	43
Playing time .....	18
Power zoom .....	31
Print mark .....	180
PROGRAM AE .....	67

---

## R

Recording level .....	79
Recording time .....	17
Rec Review .....	38
Remaining battery time indicator .....	33
Remaining tape indicator .....	33
Remote Commander .....	250
Remote sensor .....	244
RESET .....	224

---

## S

Self-diagnosis display .....	225
Self-timer recording .....	36, 50, 143, 155
Shutter speed .....	70
Signal convert function .....	204
Skip scan .....	43
Slide show .....	175
Slow playback .....	43
SPOT FOCUS .....	78
Spot light .....	35
STEADYSHOT .....	209
Stereo tape .....	229
STILL .....	59
Stylus .....	206
Sub sound .....	229
S VIDEO jack .....	45, 95, 109, 146, 158

---

## T, U, V

Tape counter .....	33
Tape PB ZOOM .....	86
Tape photo recording .....	51
Telephoto .....	31
Time code .....	33
Title .....	119, 122
Title search .....	89
Touch panel .....	24, 129
TRAIL .....	59
Transition .....	27
TV color systems .....	235
USB jack .....	183
USB Streaming .....	186
Volume .....	39

---

## W, X, Y, Z

Warning indicators .....	226
White balance .....	72
Wide-angle .....	31
Wide mode .....	53
WIPE .....	55
Write-protect switch .....	126
Write-protect tab .....	23
Zebra pattern .....	65
Zero set memory .....	88
Zoom .....	31



Printed on recycled paper

<http://www.sony.net/>

Sony Corporation Printed in Japan



3 0 7 5 4 9 4 1 2